

# CLASSIC SYSTEMS: UNIX AND THE

# The UNIX Time-Sharing System

## Dennis Ritchie and Ken Thompson

2

- Background of authors at Bell Labs
  - ▣ Both won Turing Awards in 1983
- Dennis Ritchie
  - ▣ Key developer of The C Programming Language, Unix, and Multics
- Ken Thompson
  - ▣ Key developer of the B programming language, Unix, Multics, and Plan 9
  - ▣ Also QED, ed, UTF-8



# The UNIX Time-Sharing System

## Dennis Ritchie and Ken Thompson

3

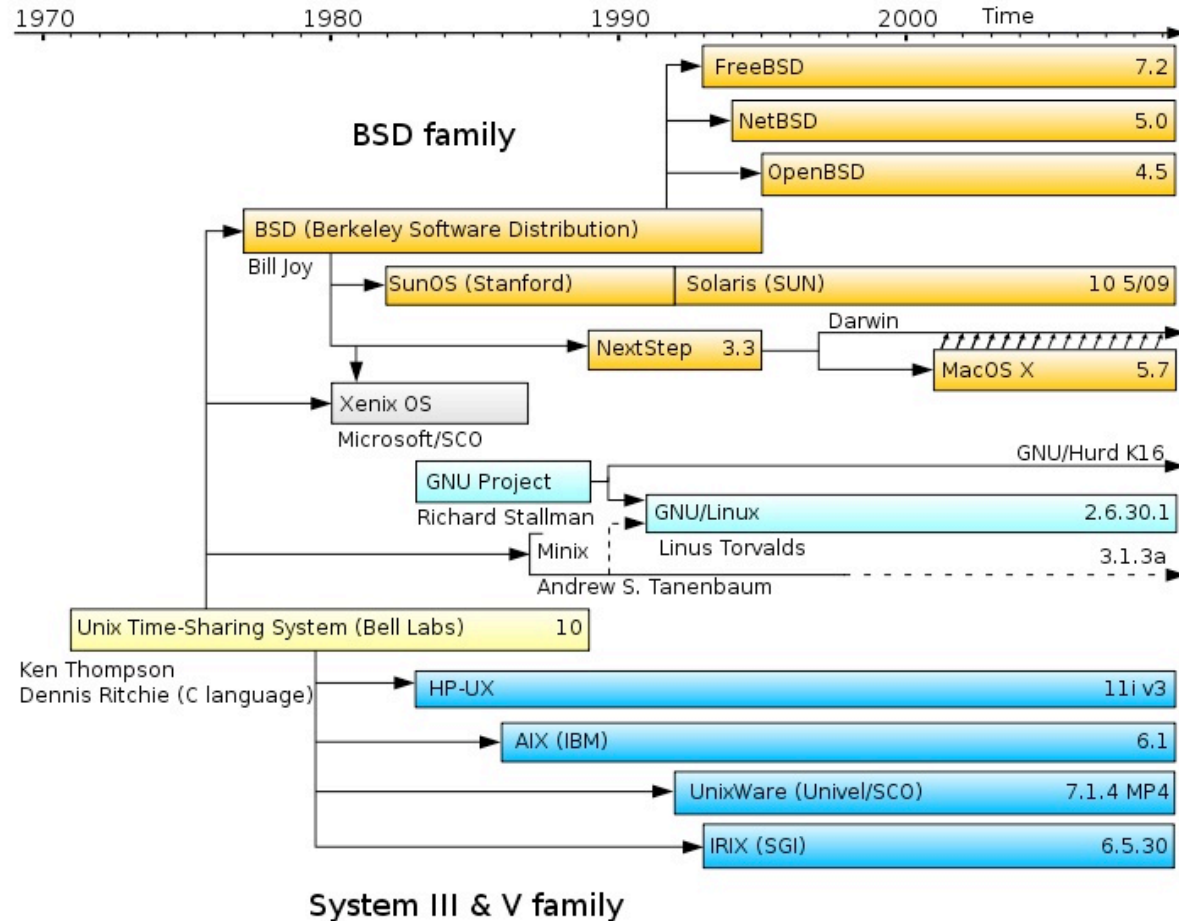

# The UNIX Time-Sharing System

Dennis Ritchie and Ken Thompson

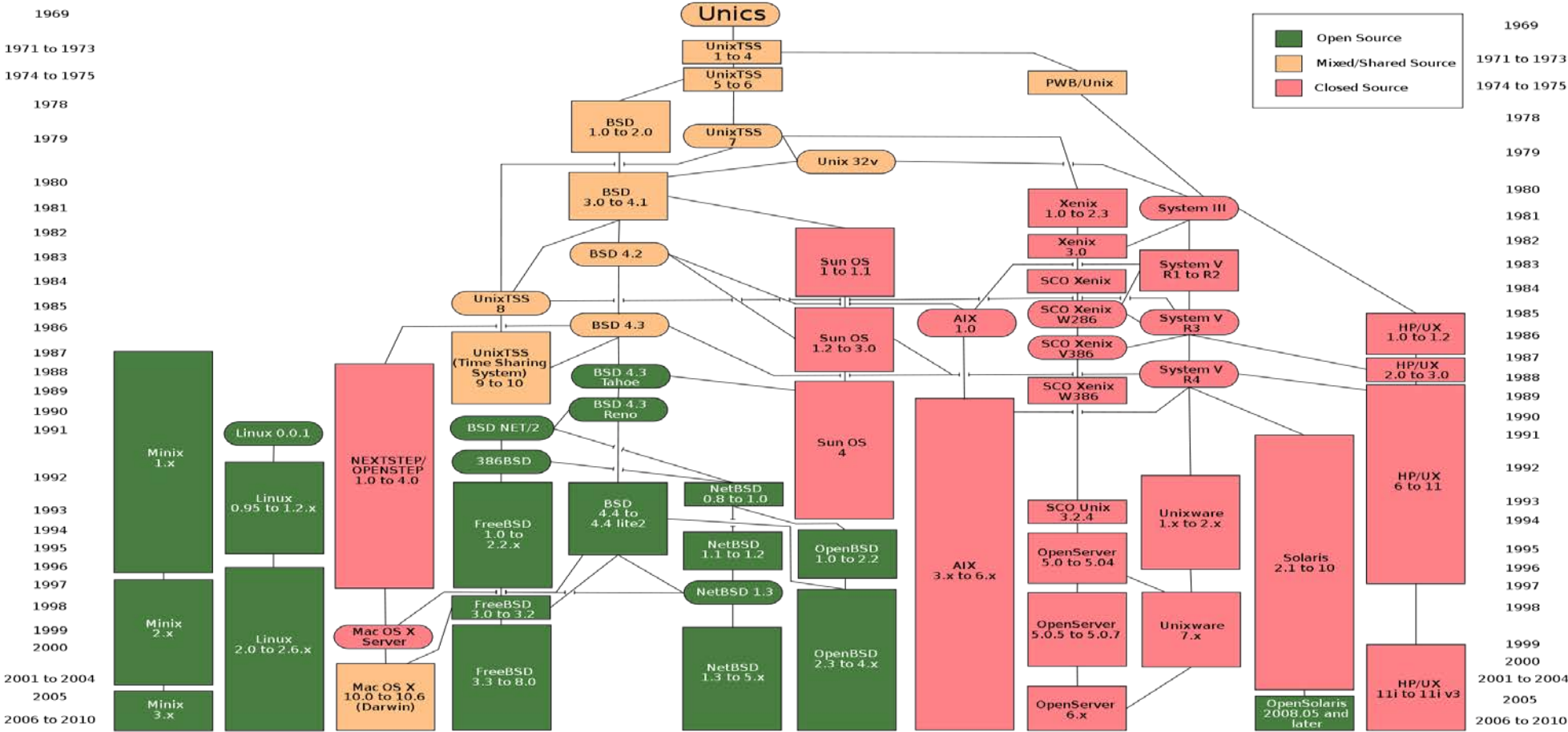

# The UNIX Time-Sharing System

## Dennis Ritchie and Ken Thompson

5

- Classic system and paper
  - ▣ described almost entirely in 10 pages
- Key idea
  - ▣ elegant combination: a few concepts that fit together well
  - ▣ Instead of a perfect specialized API for each kind of device or abstraction, the API is deliberately small

# System features

6

- Time-sharing system
- Hierarchical file system
- Device-independent I/O
- Shell-based, tty user interface
- Filter-based, record-less processing paradigm
  
- Major early innovations: “fork” system call for process creation, file I/O via a single subsystem, pipes, I/O redirection to support chains

# Version 3 Unix

7

- 1969: Version 1 ran PDP-7
- 1971: Version 3 Ran on PDP-11's
  - ▣ Costing as little as \$40k!
- < 50 KB
- 2 man-years to write
- Written in C



PDP-7



PDP-11

# File System

8

- Ordinary files (uninterpreted)
- Directories (protected ordinary files)
- Special files (I/O)



# Uniform I/O Model

9

- open, close, read, write, seek
  - ▣ Uniform calls eliminates differences between devices
  - ▣ Two categories of files: character (or byte) stream and block I/O, typically 512 bytes per block
- other system calls
  - ▣ close, status, chmod, mkdir, ln
- One way to “talk to the device” more directly
  - ▣ ioctl, a grab-bag of special functionality
- lowest level data type is raw bytes, not “records”

# Directories

10

- root directory
- path names
- rooted tree
- current working directory
- back link to parent
- multiple links to ordinary files

# Special Files

11

- Uniform I/O model
  - ▣ Each device associated with at least one file
  - ▣ But read or write of file results in activation of device
  
- Advantage: Uniform naming and protection model
  - ▣ File and device I/O are as similar as possible
  - ▣ File and device names have the same syntax and meaning, can pass as arguments to programs
  - ▣ Same protection mechanism as regular files

# Removable File System

12

- Tree-structured
- *Mount*'ed on an ordinary file
  - ▣ Mount replaces a leaf of the hierarchy tree (the ordinary file) by a whole new subtree (the hierarchy stored on the removable volume)
  - ▣ After mount, virtually no distinction between files on permanent media or removable media

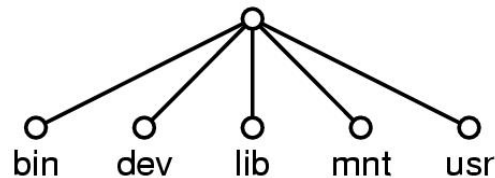

(a)

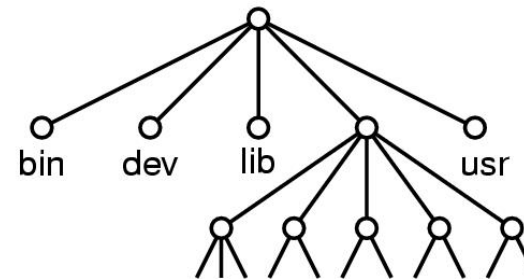

(b)

# Protection

13

- User-world, RWX bits
- set-user-id bit
- super user is just special user id

# File System Implementation

14

- System table of i-numbers (i-list)
- i-nodes
- path names  
(directory is just a special file!)
- mount table
- buffered data
- write-behind

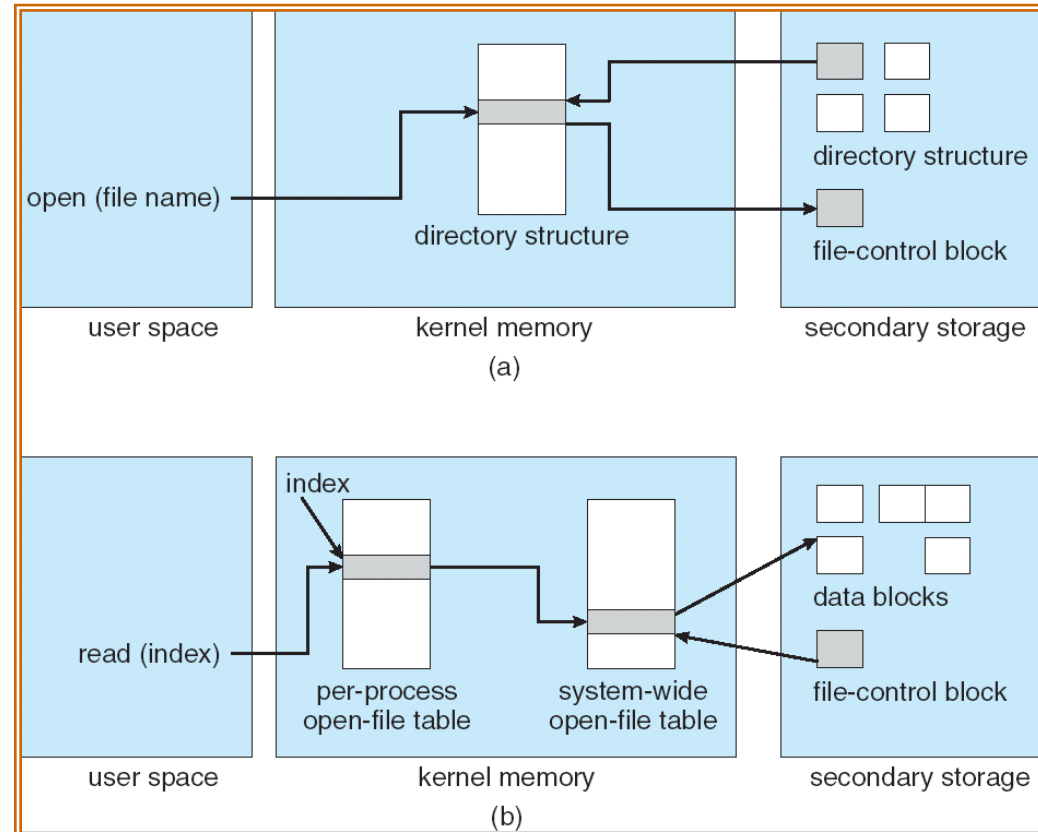

# I-node Table

15

- short, unique name that points at file info.
- allows simple & efficient fsck
- cannot handle accounting issues

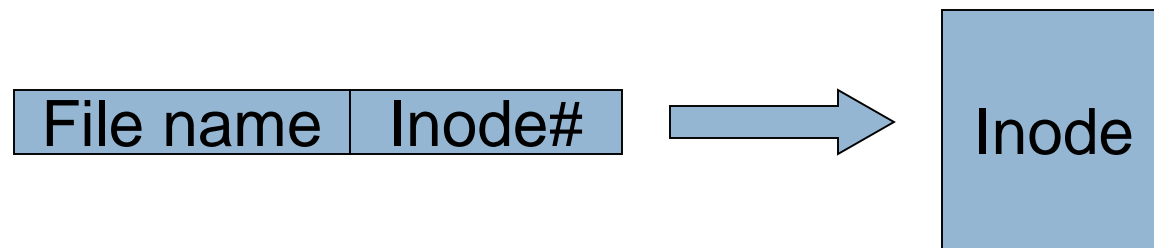

# Many devices fit the block model

16

- Disks
- Drums
- Tape drives
- USB storage
  
- Early version of the ethernet interface was presented as a kind of block device (seek disabled)
  
- But many devices used IOCTL operations heavily



# Processes and images

17

- text, data & stack segments
- process swapping
- `pid = fork()`
- pipes
- `exec(file, arg 1, ..., argn)`
- `pid = wait()`
- `exit(status)`

# Easy to create pipelines

18

- A “pipe” is a process-to-process data stream, could be implemented via bounded buffers, TCP, etc
- One process can write on a connection that another reads, allowing chains of commands

```
% cat *.txt | grep foo | wc
```

- In combination with an easily programmable shell scripting model, very powerful!

# The Shell

19

- `cmd arg1 ... argn`
- `stdio & I/O redirection`
- `filters & pipes`
- `multi-tasking from a single shell`
- `shell is just a program`
  
- `Trivial to implement in shell`
  - ▣ `Redirection, background processes, cmd files, etc`

# Traps

20

- Hardware interrupts
- Software signals
- Trap to system routine

# Perspective

21

- Not designed to meet predefined objective
- Goal: create a comfortable environment to explore machine and operating system
- Other goals
  - ▣ Programmer convenience
  - ▣ Elegance of design
  - ▣ Self-maintaining

# Perspective

22

- But had many problems too. Here are a few:
  - Weak, rather permissive security model
  - File names too short and file system damaged on crash
  - Didn't plan for threads and never supported them well
  - "Select" system call and handling of "signals" was ugly and out of character w.r.t. other features
  - Hard to add dynamic libraries (poor handling of processes with lots of "segments")
  - Shared memory and mapped files fit model poorly
- ...in effect, the initial simplicity was at least partly because of some serious limitations!

# Even so, Unix has staying power!

23

- Today's Linux systems are far more comprehensive yet the core simplicity of Unix API remains a very powerful force
- Struggle to keep things simple has helped keep O/S developers from making the system specialized in every way, hard to understand
- Even with modern extensions, Unix has a simplicity that contrasts with Windows .NET API... Win32 is really designed as an internal layer that libraries invoke, but that normal users never encounter.

# “THE”-Multiprogramming System

Edsger W. Dijkstra

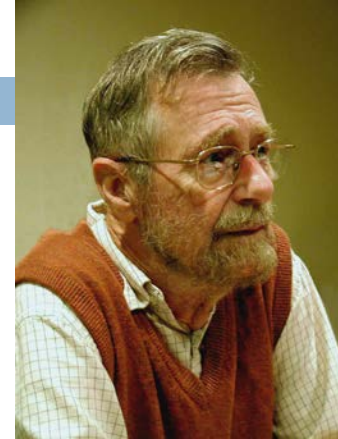

- Received Turing Award in 1972
- Contributions
  - ▣ Shortest Path Algorithm, Reverse Polish Notation, Bankers algorithm, semaphore's, self-stabilization
- Known for disliking 'goto' statements and using computers!



# “THE”-Multiprogramming System

Edsger W. Dijkstra

- Never named “THE” system; instead, abbreviation for “Technische Hogeschool Eindhoven”
- Batch system (no human intervention) that supported multitasking (processes share CPU)
  - ▣ THE was *not* multiuser
- Introduced
  - ▣ software-based memory segmentation
  - ▣ Cooperating sequential processes
  - ▣ semaphores

# Design

- Layered structure
  - ▣ Later Multics has layered structure, ring segmentation
- Layer 0 – the scheduler
  - ▣ Allocated CPU to processes, accounted for blocked proc's
- Layer 1 – the pager
- Layer 2 – communication between OS and console
- Layer 3 – managed I/O
- Layer 4 – user programs
- Layer 5 – the user
  - ▣ “Not implemented by us”!

# Perspective

---

- Layered approach
  - ▣ Design small, well defined layers
  - ▣ Higher layers dependent on lower ones
    - Helps prove correctness
    - Helps with debugging
- Sequential process and Semaphores

# Next Time

- Read and write review for Tuesday, September 4:
  - ▣ **Required** *Bitcoin: A peer-to-peer electronic cash system*. Nakamoto, Satoshi. Consulted 1.2012 (2008): 28  
<http://nakamotoinstitute.org/bitcoin/>
  - ▣ **Optional** *Bitcoin and Cryptocurrency Technologies: A Comprehensive Introduction*. A. Narayanan, J. Bonneau, E. Felten, A. Miller, S. Goldfeder. Princeton University Press; 2016. Read Preamble, and Chapters 1 and 2.  
[https://d28rh4a8wq0iu5.cloudfront.net/bitcointech/readings/princeton\\_bitcoin\\_book.pdf](https://d28rh4a8wq0iu5.cloudfront.net/bitcointech/readings/princeton_bitcoin_book.pdf)
  - ▣ **Optional** *Majority is not enough: Bitcoin mining is vulnerable*. Eyal, Ittay, and Emin Gun Sirer. arXiv preprint arXiv:1311.0243 (2013).  
<http://www.cs.cornell.edu/~ie53/publications/btcProcArXiv.pdf>

# Next Time

- Read and write review for Thursday, September 6:
  - ▣ **Required** The Design and Implementation of a Log-Structured File System, Mendel Rosenblum and Ousterhout. Proceedings of the thirteenth ACM symposium on Operating systems principles, October 1991, pages 1--15. On the duality of operating system structures, H. C. Lauer and R. M. Needham. ACM SIGOPS Operating Systems Review Volume 12, Issue 2 (April 1979), pages 3--19.
  - ▣ **Optional:** A Fast File System for UNIX. Marshall K. McKusick, William N. Joy, Samuel J. Leffler, Robert S. Fabry. ACM TOCS 2(3), Aug 1984, pages 181-197.

# Next Time

- Read and write review:
- MPO – due tomorrow, Friday
- Project Proposal due in a week and a half, Tuesday, September 11
  - ▣ talk to me and other faculty and email and talk to me
- Check website for updated schedule