



**In 2020SP, this lecture
and lecture 20 are both
optional extra material**

CS 5412/LECTURE 17
LEAVE NO TRACE BEHIND

Ken Birman
Spring, 2020

THE PRIVACY PUZZLE FOR IOT

We have sensors everywhere, including in very sensitive settings.

They are capturing information you definitely don't want to share.

... seemingly arguing for brilliant sensors that do all the computing.

- But sensors are power and compute-limited.
- Sometimes, only cloud-scale datacenters can possibly do the job!

THINGS THAT CAN ONLY BE DONE ON THE CLOUD

Training models for high quality image recognition and tagging. Classifying complex images.



High quality speech, including regional accents and individual styles.

Correlating observations from video cameras with shared knowledge

- Example: A smart highway where we are comparing observations of vehicles with previously computed motion trajectories
- Is Bessie the cow likely to give birth soon? Will it be a difficult labor?
- What plant disease might be causing this form of leaf damage?

BUT THE CLOUD IS NOT GOOD ON PRIVACY

Many cloud computing vendors are incented by advertising revenue.

- Google just wants to show ads that the user will click on.
- Amazon wants to offer products this user might buy.

Consider medications: a big business in America. But to show a relevant ad for a drug to treat mental health, or diabetes, entails knowing the user's health status.

Even showing the ad could leak information that a third party, like the ISP carrying network traffic, might “steal”.

THE LAW CAN'T HELP (YET)

Lessing: “East code versus West code”.

Main points:

- The law is far behind the technology curve, in the United States.
- Europe may be better, but is a less innovative technology community.
- So our best hope is to just build better technologies here.

SOME PROVIDERS AREN'T INCENTED!

We should separate cloud providers into two groups.

One group of cloud providers has an inherent motivation to violate privacy for revenue reasons and will “fight against” constraints.

- Here we need to block their effort to spy on the computation.

A second group doesn't earn their revenue with ads.

- These cloud vendors might *cooperate* to create a secure and private model.

UNCOOPERATIVE PROVIDER



Intel has created special hardware to assist for this case: iSGX. Stands for Software Guard Extensions.

Basically, they offer a way to run in a “secure context” within a vendor’s cloud. If the operator wanted to, it can’t peek into the execution context.

We will look at it SGX detail after first seeing some other kinds of issues.

A DIFFERENT KIND OF ATTACK: INVERTING A MACHINE LEARNED MODEL

Machine learning systems generally operate in two stages

- Given a model, they use labeled data to “train” the model (like fitting a curve to a set of data points, by finding parameters to minimize error).
- Then the active stage takes unlabeled data and “classifies” it by using the model to estimate the most likely labels from the training set.
- The special case of “unsupervised” learning arises when teaching a system to drive a car or fly a plane or helicopter. Here instead of labels, we have some other form of “output signal” we want to mimic.

INVERTING A MACHINE-LEARNED MODEL

But such a model can encode private data.

For example, a model trained on your activities in your home might “know” all sorts of very private things even if the raw input isn’t retained!

In fact we can take the model and run it backwards to recreate synthetic inputs that it has a strong match against. This has been done in many studies: the technique “inverts” the model.

TRAFFIC ANALYSIS ATTACKS

Some attacks don't actual try to “see” the actual data.

Instead the attacker might just try to monitor the system carefully, as a way to see who is talking to whom, or sending big objects.

A malicious operator can use this as indirect evidence, or try and disrupt the computation at key moments to cause trouble.

SOUNDS PRETTY BAD!

If our cloud provider wants to game the system, there are a million ways to evade constraints, and they may even be legal!

So realistically, with an uncooperative cloud operator, our best bet is to just not use their cloud.

Even hybrid cloud models seem to be infeasible if you need to protect sensitive user data.

DEEP DIVE 1: SGX

Let's drill down on the concrete options.

First we will look closer at SGX, since this is a product from a major vendor.

SGX CONCEPT

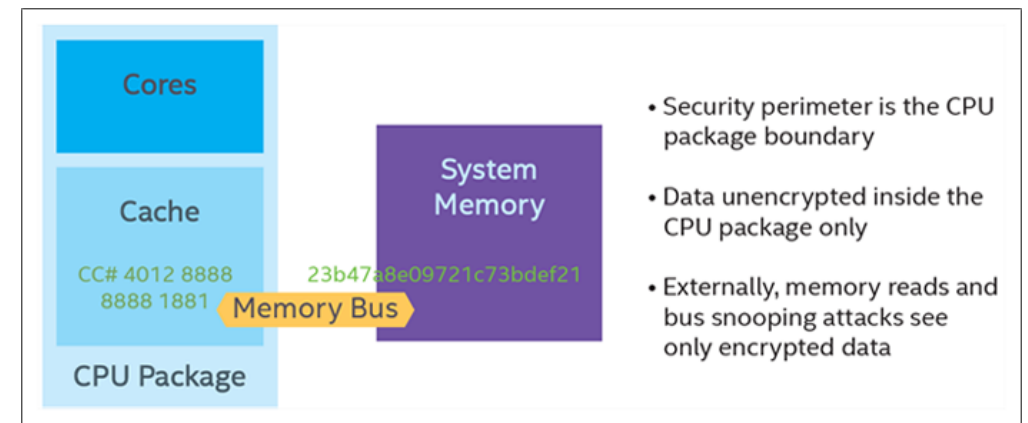

The cloud launches the SGX program, which was supplied by the client.

The program can now read data from the cloud file system or accept a secured TCP connection (HTTPS) from an external application.

The client sends data, and the SGX-secured enclave performs the task and sends back the result. The cloud vendor can only see encrypted information, and never has any access to decrypted data or code.

SGX EXAMPLE



Drat! I can't see anything!

External client system, or IoT Sensor



**HTTPS connection
(secure!)**

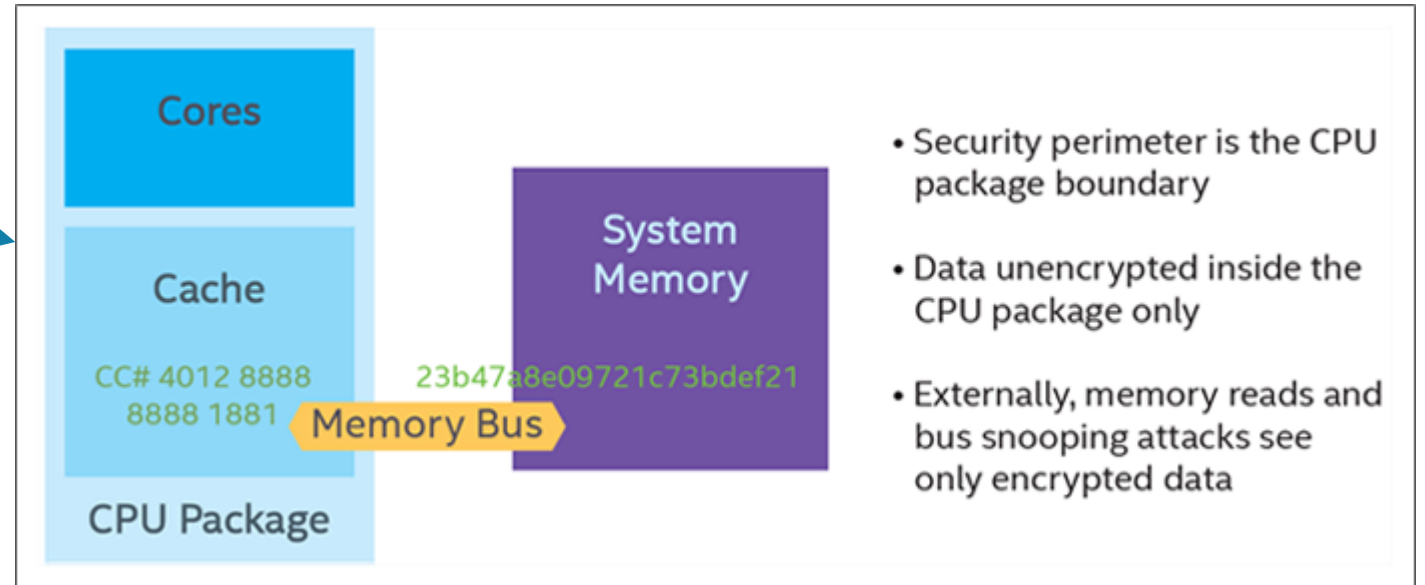

Intel.com

SGX LIMITATIONS

In itself, SGX won't protect against monitoring attacks.

And it can't stop someone from disrupting a connection or accosting a user and saying “why are you using this secret computing concept? Tell me or go to jail!”

And it is slow...

SGX RECEPTION HAS BEEN MIXED

Some adoption, but performance impact is a continuing worry.

There have been some successful exploits against SGX that leverage Intel's hardware caching and prefetching policies. (“Leaks”)

Using SGX requires substantial specialized expertise. And SGX can't leverage specialized hardware accelerators, like GPU or TPU or even FPGA (they could have “back channels” that leak data).

COOPERATIVE PRIVACY LOOKS MORE PROMISING

If the vendor is willing to work with the cloud developer many new options emerge. Such a vendor guarantees: “We won’t snoop, and we will isolate users so that other users *can’t* snoop”.

A first simple idea is for the vendor to provide a guaranteed “scrubbing” for container virtualization.

- Containers that start in a known and “clean” runtime context.
- After the task finishes, they clean up and leave no trace at all.



ORAM MODEL



ORAM: Oblivious RAM (multiuser system that won't leak information)

Idea here is that if the cloud operator can be trusted but “other users” on the same platform cannot, we should create containers that leak no data.

Even if an attacker manages to run on the same server, they won't learn anything. All leaks are blocked (if the solution covered all issues, that is)

Turns out to be feasible with special design and compilation techniques

ENTERPRISE VLAN AND VIRTUALLY PRIVATE NETWORKING (VPN)

If the cloud vendor is able to “set aside” some servers, but can’t provide a private network, these tools let us create a form of VPN in which traffic for application A shares the network with traffic for other platforms, but no leakage occurs.

In practice the approach is mostly via cryptography.

For this reason, “traffic analysis” could still reveal some data.

PRIVACY WITH μ -SERVICES

Vendor or μ -service developer will need to implement a similar “leave no trace” guarantee.

Use cryptography to ensure that data on the wire can't be interpreted

- With FPGA bump-in-the-wire model, this can be done at high speeds.
- So we can pass data across the cloud message bus/queue safely as long as the message tag set doesn't reveal secrets.
- Cloud vendor could even audit the μ -services, although this is hard to do and might not be certain to detect private data leakage

DATABASES WITH SENSITIVE CONTENT

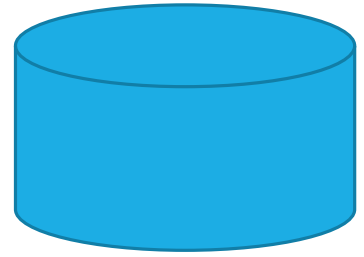

Many applications turn out to need to create a *single* database with data from *multiple* clients, because some form of “aggregated” data is key to what the μ -service is doing.

- Most customers who viewed product A want to compare with B.
- If you liked that book, you will probably like this one too.
- People like you who live in Ithaca love Gola Osteria.
- 88% of people with this gene variant are descended from Genghis Khan

ISSUE WITH DATABASE QUERIES

Many people assume that we can anonymize databases, or limit users to queries that sum up (“aggregate”) data over big groups.

But in fact it is often surprisingly easy to de-anonymize the data, or use known information to “isolate” individuals.

- How many bottles of wine are owned by people in New York State that have taught large MEng-level cloud computing courses?
- Seems to ask about a large population, but actually asks about me!

BEST POSSIBLE? DIFFERENTIAL PRIVACY

Cynthia Dwork has invented a model called “Differential Privacy”.

We put our private database on a trusted server. It permits queries (normally, aggregation operations like average, min, max) but not retrieving individual data. ***And it injects noise into results.***

Noise level can be tuned to limit the rate at which leakage occurs.

BOTTLES OF WINE QUERY

For example, if the aggregation query includes a random extra number in the range $[-10000, 10000]$, then an answer like “72” tells you nothing about Ken’s wine cellar.

There are several ways to add noise, and this is a “hot topic”.

But for many purposes, noisy results aren’t very useful.

➤ “I can’t see to the right. How many cars are coming?”

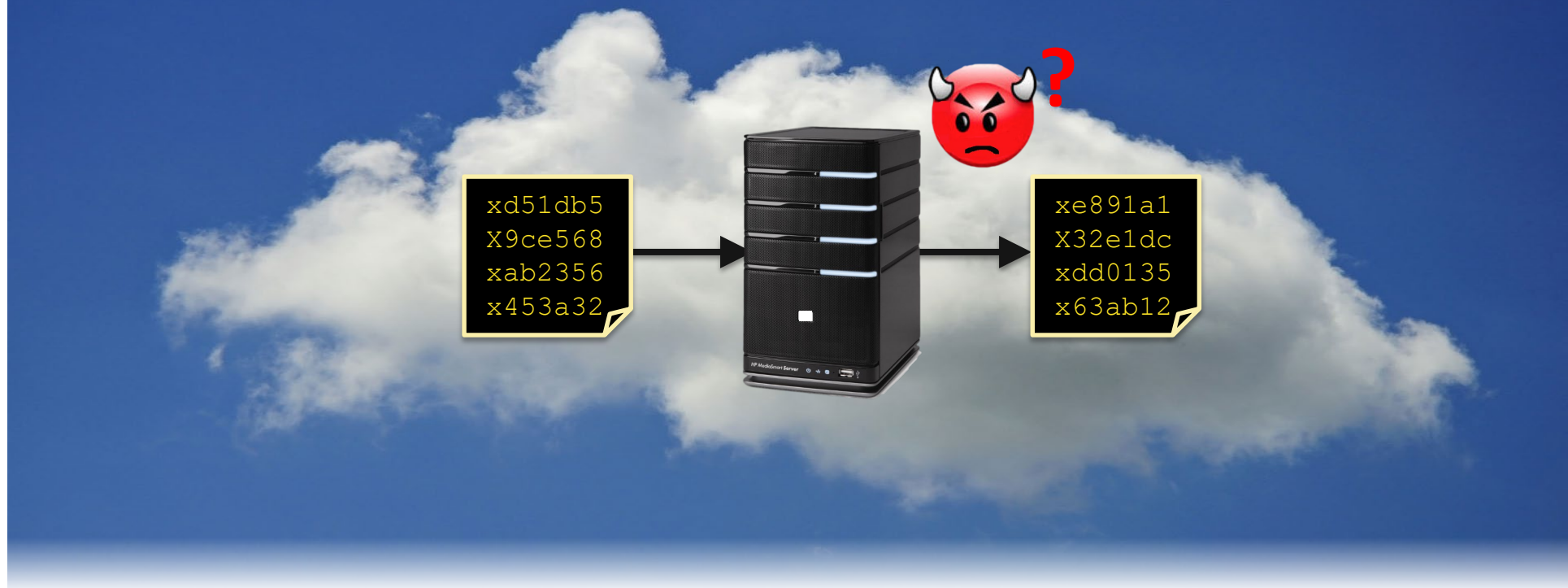

Building systems that compute on encrypted data

Raluca Ada Popa
MIT PhD, now a professor at Berkeley



Security experts warn of increasing data breaches and privacy risks

LivingSocial Hacked — More Than 50 Million Customer Names, Emails, Birthdates and Encrypted Passwords

Accessed (Intern

Some Victims of Online Hacking Edge Into the Light

APRIL 26, 2013 AT 1:15 PM PT

LivingSocial, the daily deal site, is owned in part by Amazon.com.

Compromise of confidential data is prevalent

WordPress firm Automattic suffers root-level hack

Summary: Hackers gained administrative privileges to Automattic's servers, WordPress founder Matt Mullenweg has said



By Tom Espiner | April 14, 2011 -- 13:31

Follow @tomespiner

Don't Trust Facebook with Employee's Revelations

Privacy, security still top cloud concerns

Asia Cloud Forum editors | November 13, 2013

Asia Cloud Forum

An online survey of Microsoft partners has revealed that traditional concerns about cloud services remain among enterprises in the region.

<http://www.cs.cornell.edu/courses/cs5412/2020sp>

Problem setup

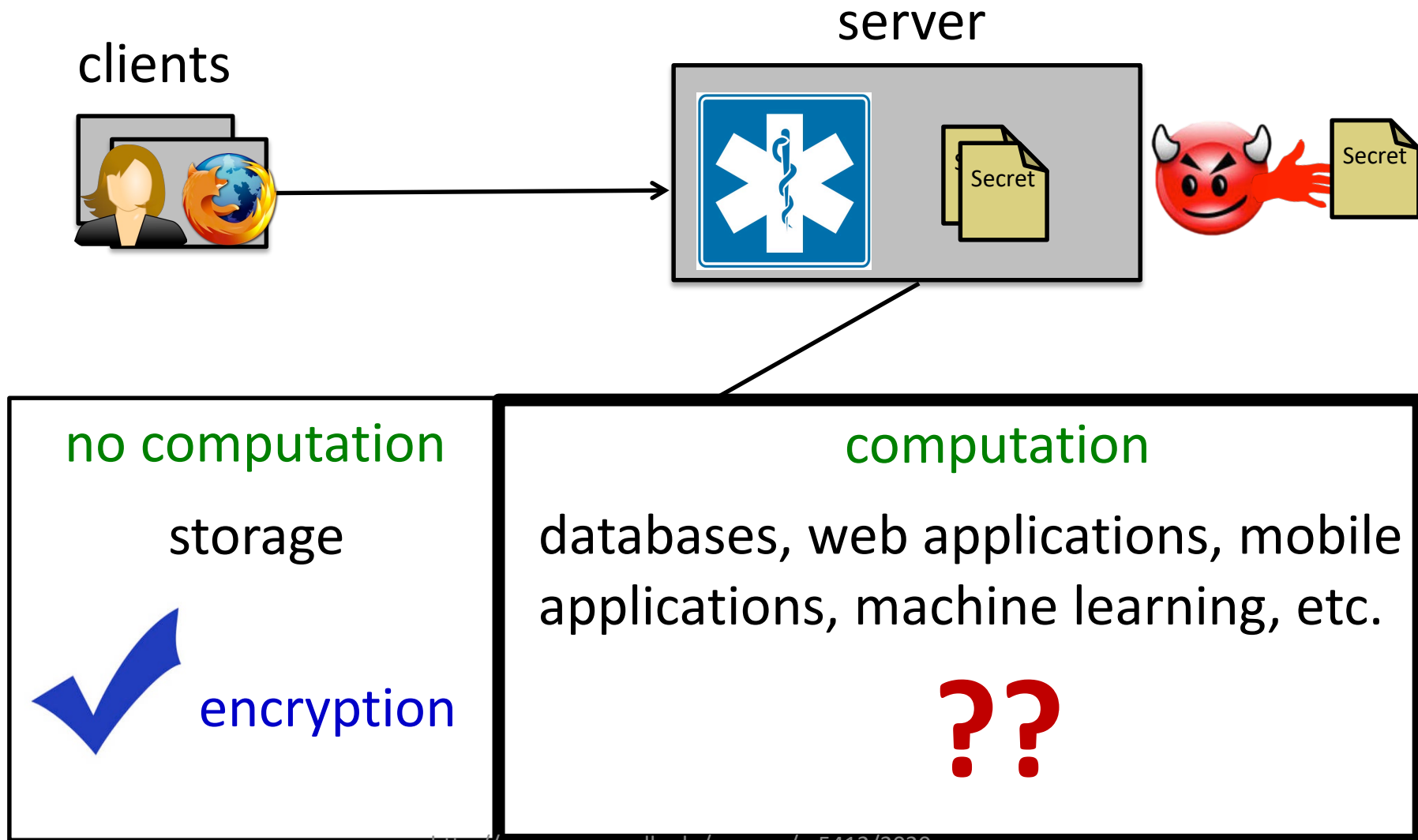

Current systems strategy

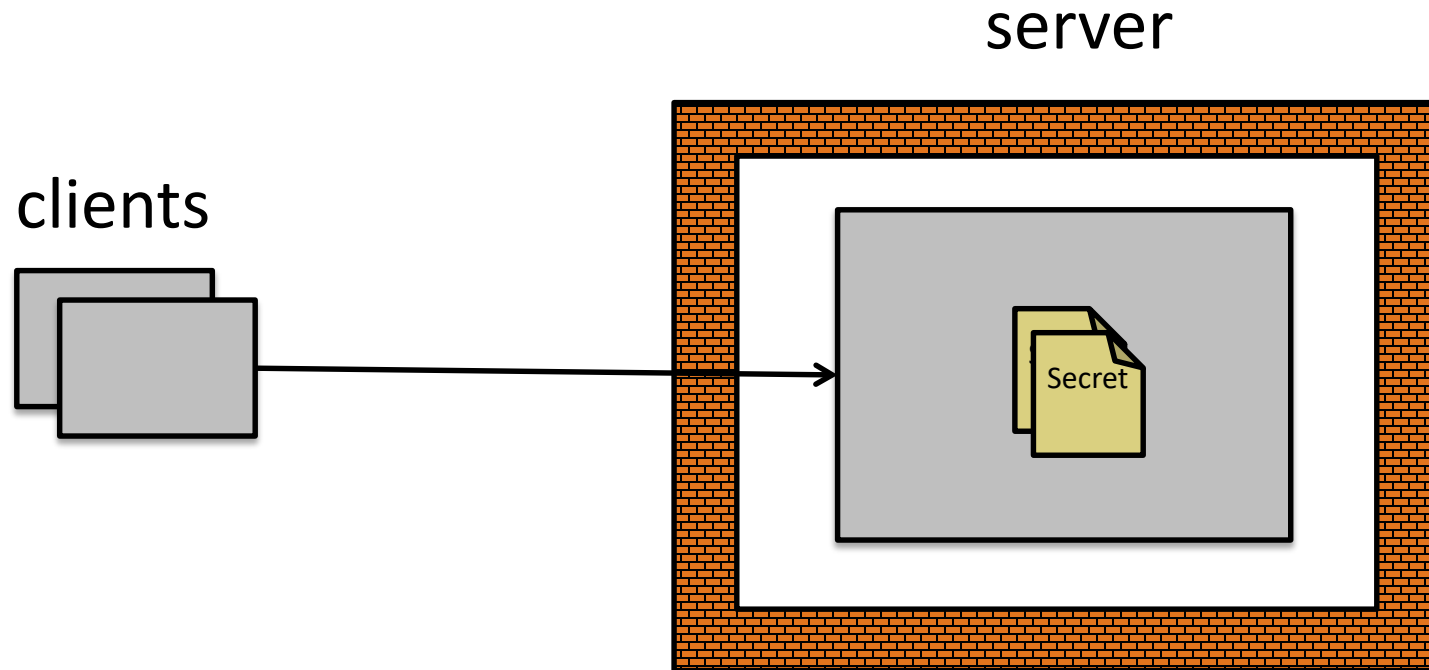

Prevent attackers from breaking into servers

Lots of existing work

- Checks at the operating-system level
- Language-based enforcement of a security policy
- Static or dynamic analysis of application code
- Checks at the network level
- Trusted hardware

...

**Data still leaks even with
these mechanisms**

because

attackers eventually break in!

Attacker examples

Attacker:

hackers



cloud employees



increasingly many companies store data on external clouds

government



accessed private data according to



<http://www.cs.cornell.edu/courses/cs5412/2020sp>

Reason they succeed:

software is complex

insiders: legitimate server access!

e.g., physical access

[Raluca Popa's] work

Systems that protect confidentiality even against
attackers with access to all server data

My approach

Servers store, process, and compute on encrypted data *in a practical way*

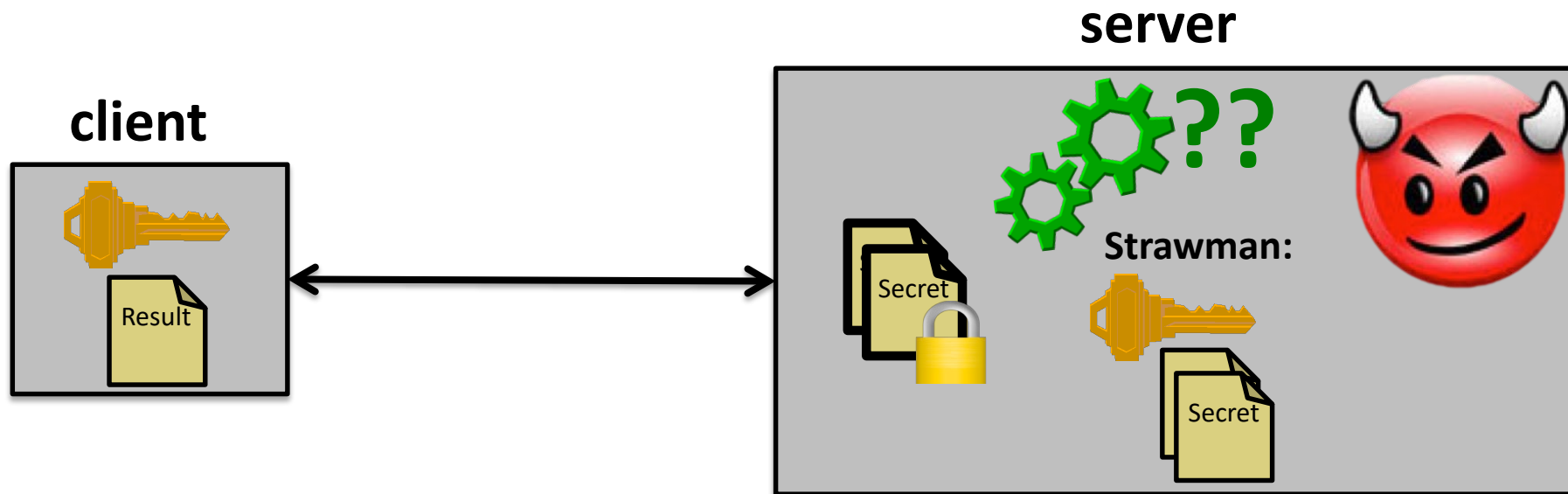

Computing on encrypted data in cryptography

[Rivest-Adleman-Dertouzos'78]

Fully homomorphic encryption (**FHE**) [Gentry'09]

prohibitively slow, e.g., slowdown X 1,000,000,000

My work: **practical systems**

real-world performance + large class of real applications + meaningful security



My contributions



System:

Server under attack:

Databases: **CryptDB** [SOSP'11][CACM'12]
mOPE, adjJOIN
[Oakland'13]

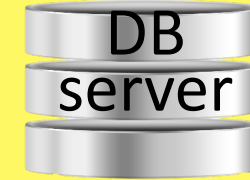

Web apps: **Mylar** [NSDI'14]
multi-key search

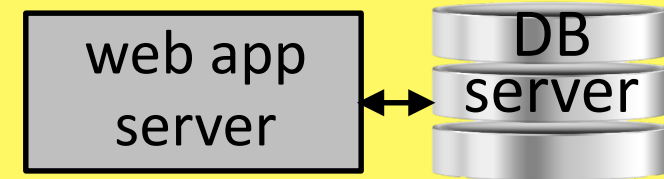

Mobile apps: **PrivStats** [CCS'11]
VPriv [Usenix Security'09]

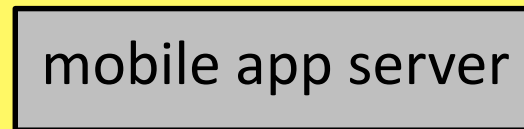

Theory:

In general: **Functional encryption** [STOC'13] [CRYPTO'13]

<http://www.cs.cornell.edu/courses/cs5412/2020sp>

Combine systems and cryptography

1. identify core operations needed

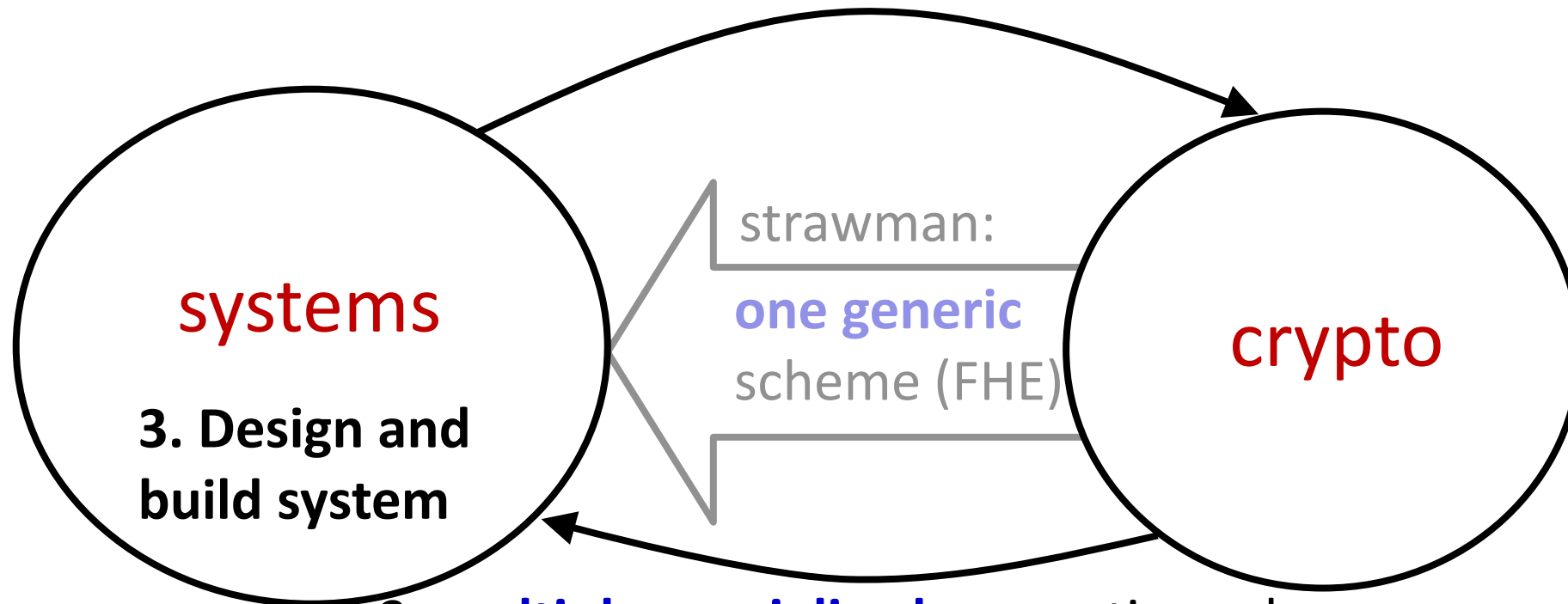

2. **multiple specialized** encryption schemes

New schemes:

- mOPE, adjJOIN for CryptDB
- **multi-key search for Mylar**

My contributions

System:

Databases: **CryptDB**

Web apps: **Mylar**



Mobile apps: **PrivStats**
VPriv



Theory:

In general: **Functional encryption**

Server under attack:

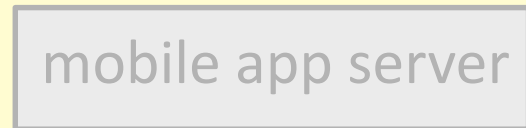
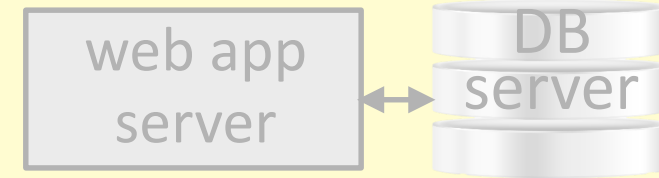
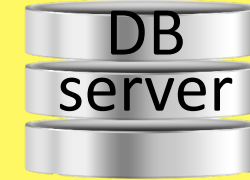

CryptDB

[SOSP'11: **Popa**-Redfield-Zeldovich-Balakrishnan]

First **practical** database system (DBMS) to process most SQL queries on encrypted data

Related work

- **Systems work:** [Hacigumus et al.'02][Damiani et al.'03][Ciriani et al.'09]
 - no formal confidentiality guarantees
 - restricted functionality
 - client-side filtering
- **Theory work:**
 - **General computation: FHE** [Gentry'09]
 - very strong security: **forces slowdown - many queries must always scan and return the whole DB**
 - prohibitively slow ($10^9\times$)
 - **Specialized schemes** [Amanatidis et al.'07][Song et al.'00][Boldyreva et al.'09]

Setup

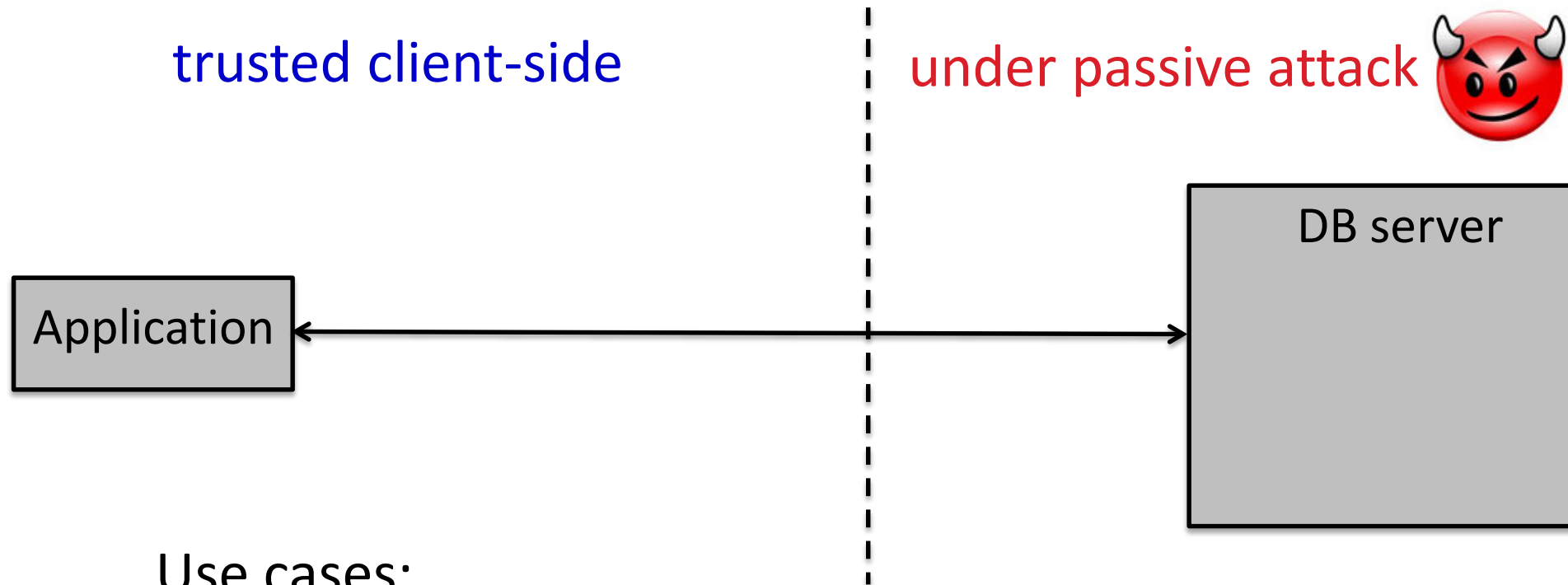

Use cases:

- Outsource DB to the cloud (DBaaS)
 - e.g. Encrypted BigQuery
- Local cluster: hide DB content from sys. admins.

Setup

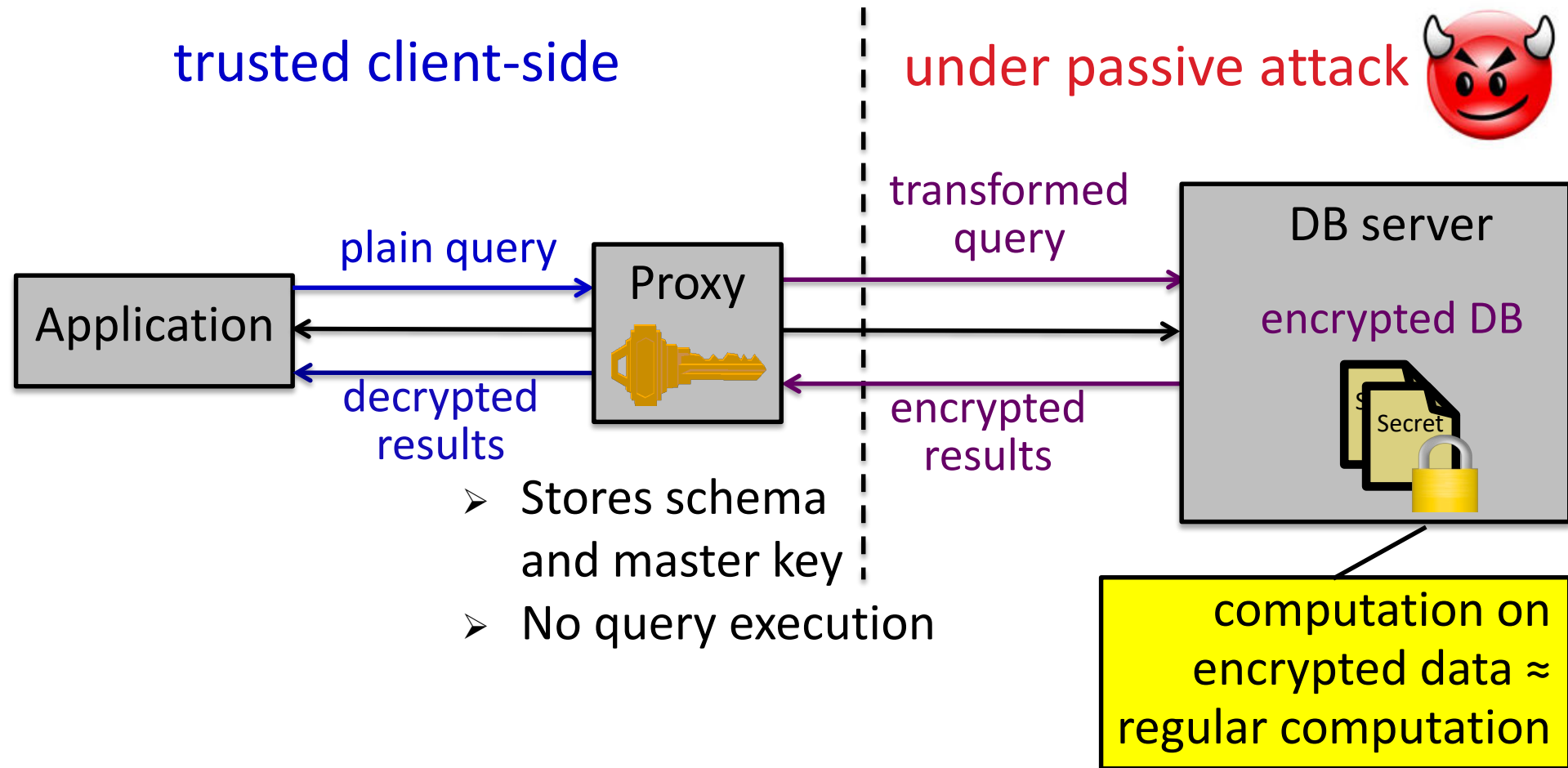

Example

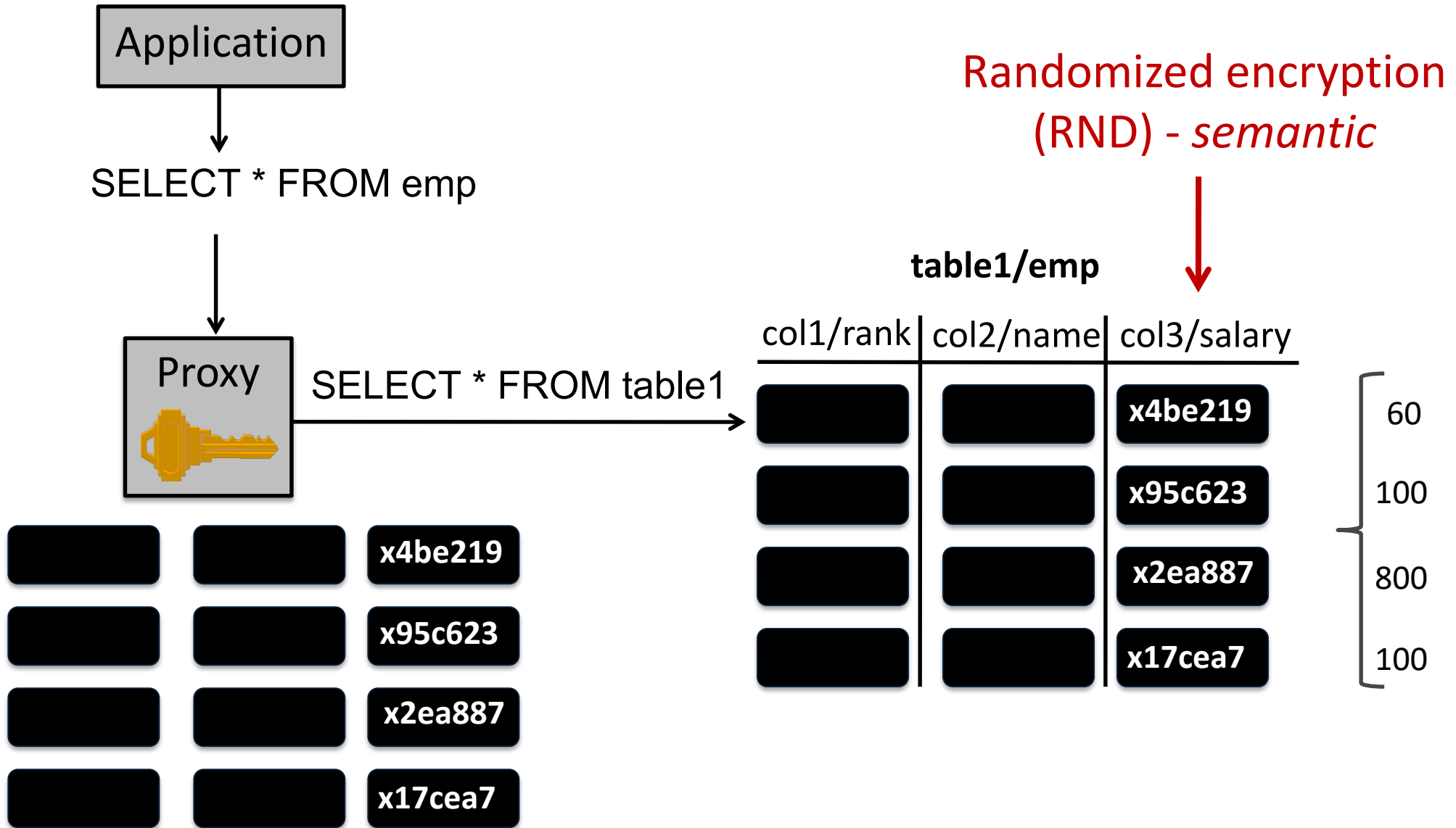

Example

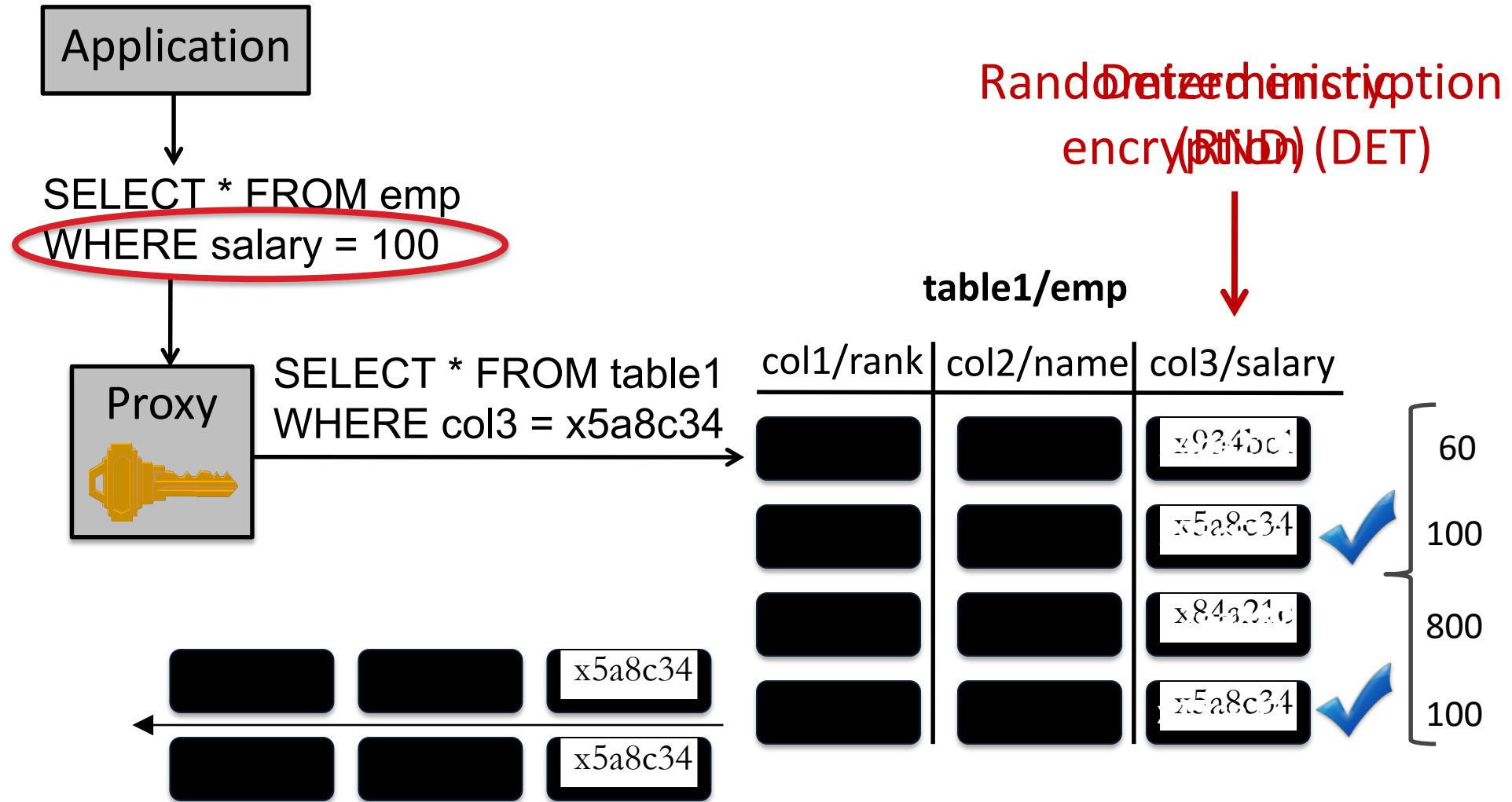

Example

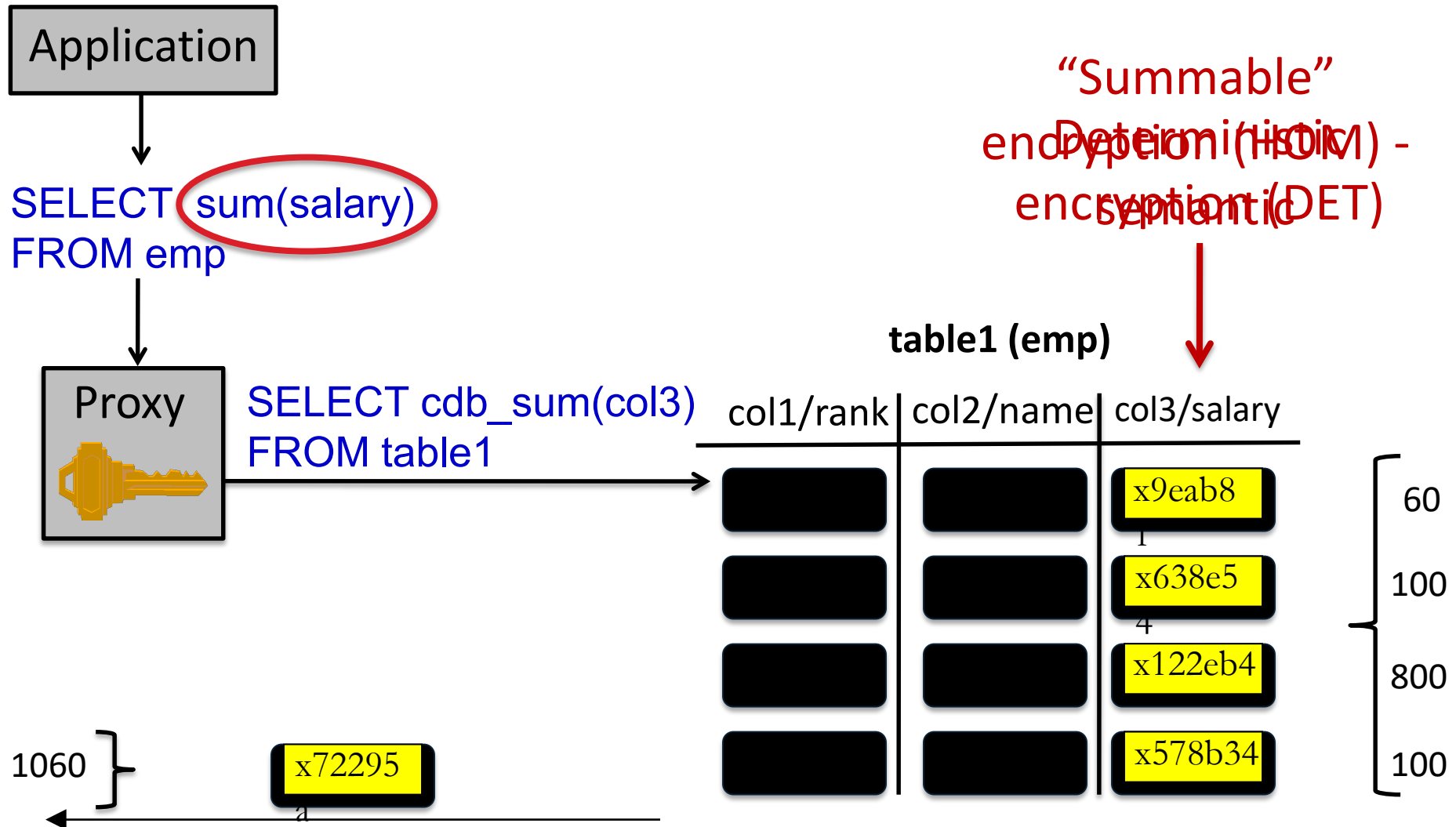

Techniques

1. Use SQL-aware set of efficient encryption schemes (meta technique!)



Most SQL can be implemented with a few core operations

2. Adjust encryption of data based on queries
3. Query rewriting algorithm

1. SQL-aware encryption schemes

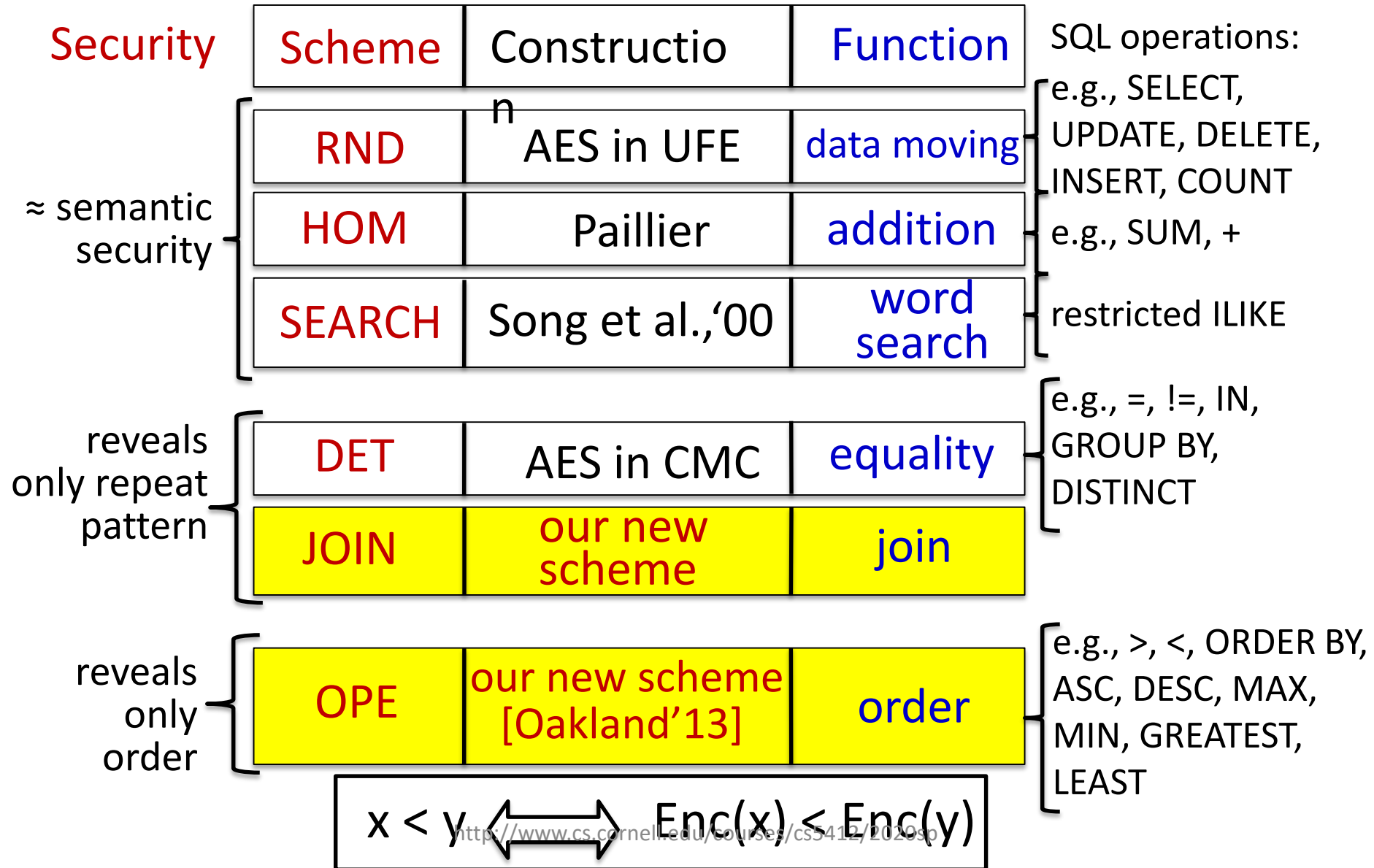

How to encrypt each data item?

- Goals:
1. Support queries
 2. Use most secure encryption schemes

Challenge: may not know queries ahead of time

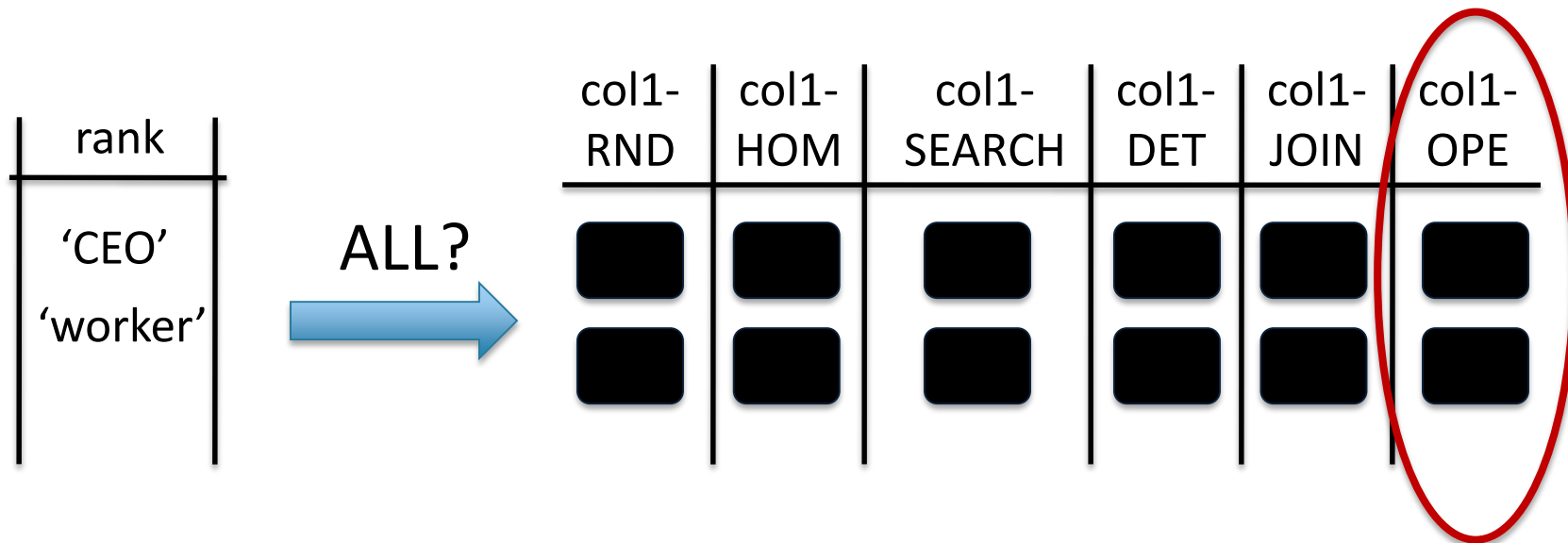

Onion



Onion of encryptions

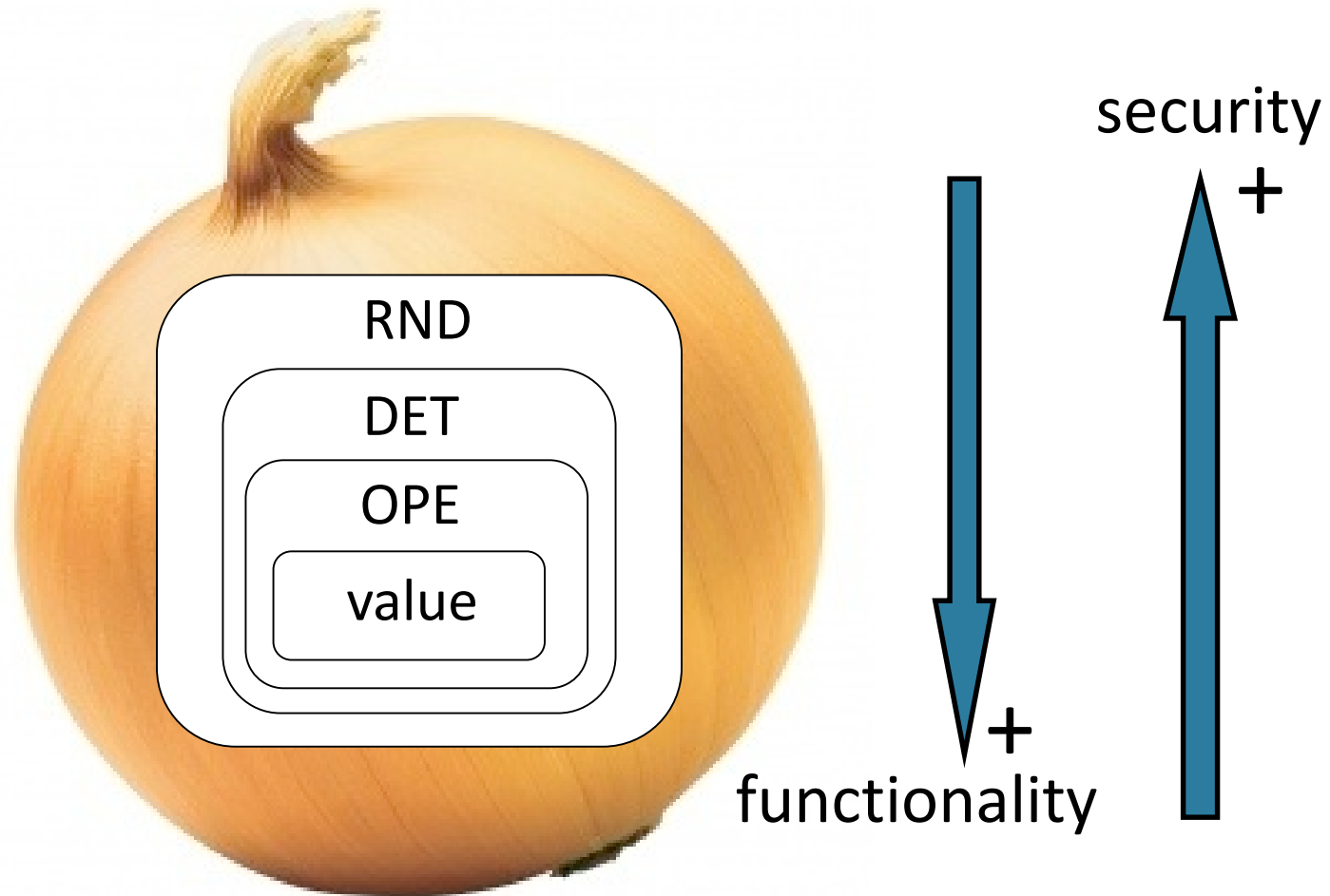

Adjust encryption: strip off layer of the onion

Onions of encryptions

1 column

3 columns

each value

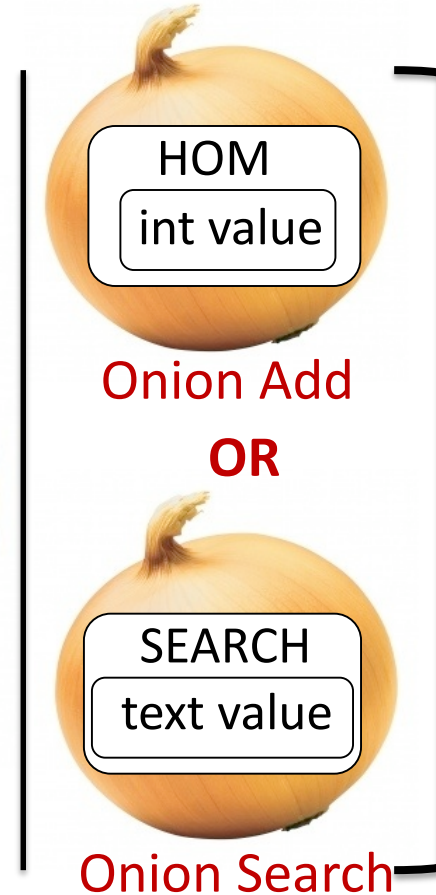
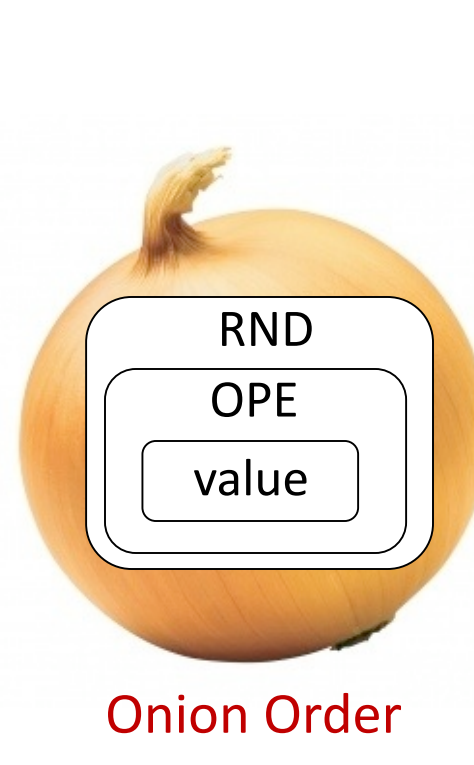
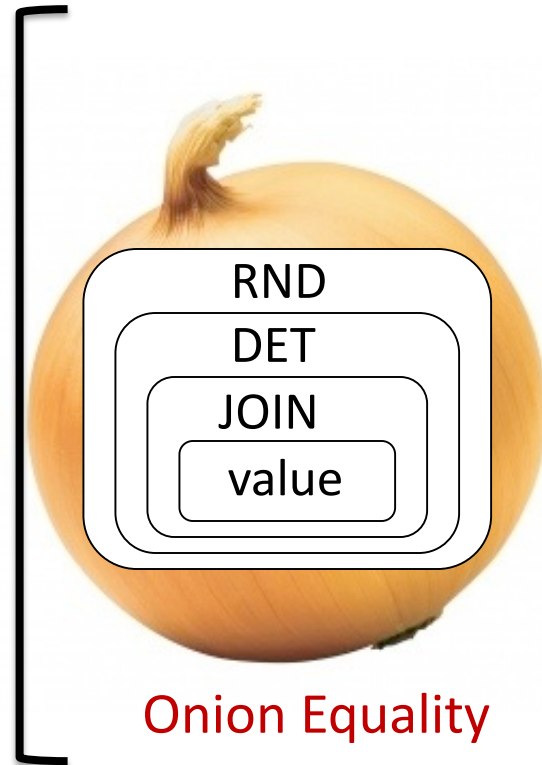
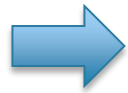

Same key for all items in a column for same onion layer

Onion evolution

- Start out the database with the most secure encryption scheme
- If needed, adjust onion level
 - Proxy gives decryption key to server
 - Proxy remembers onion layer for columns

Lowest onion level is never removed

Example

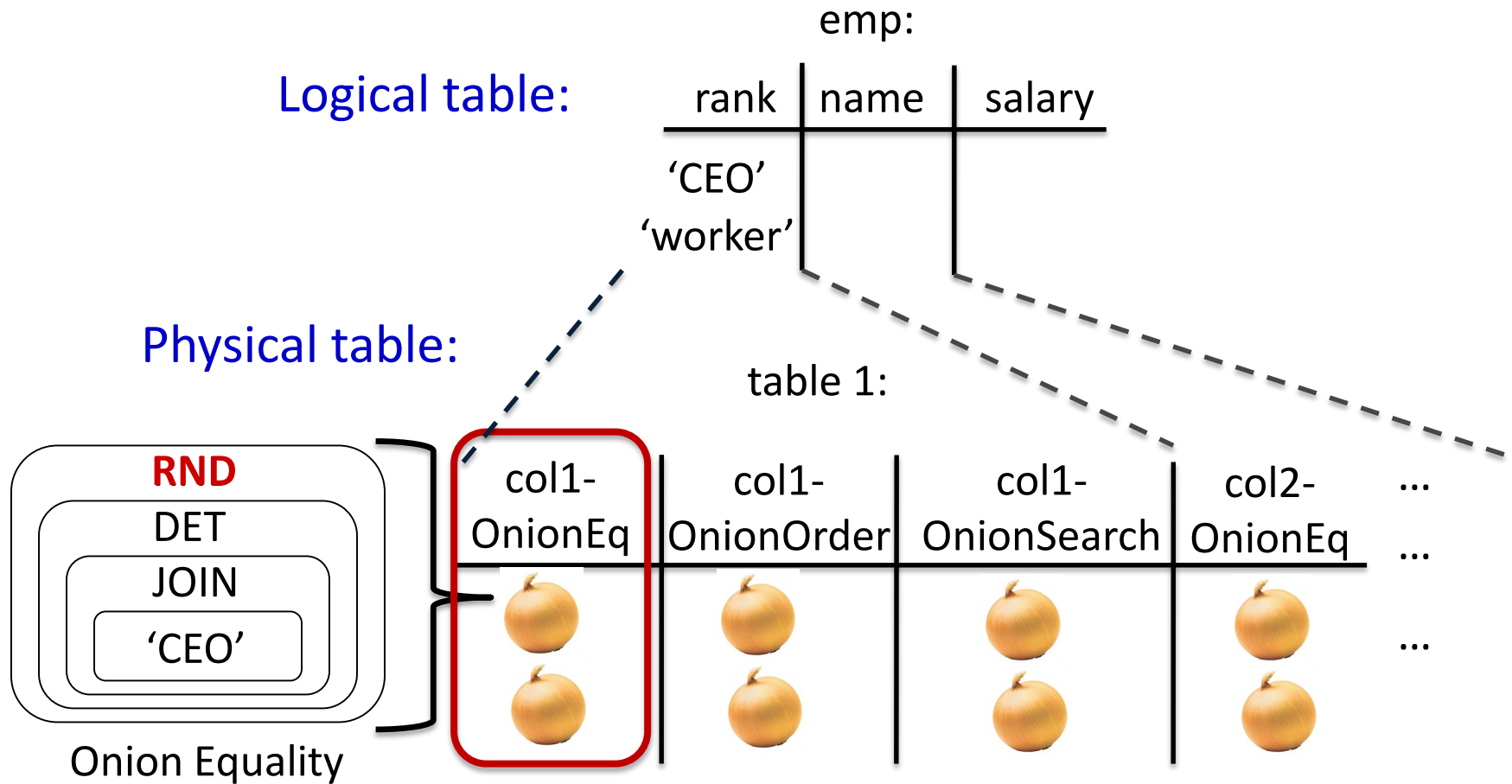

`SELECT * FROM emp WHERE rank = 'CEO'`

Example (cont'd)

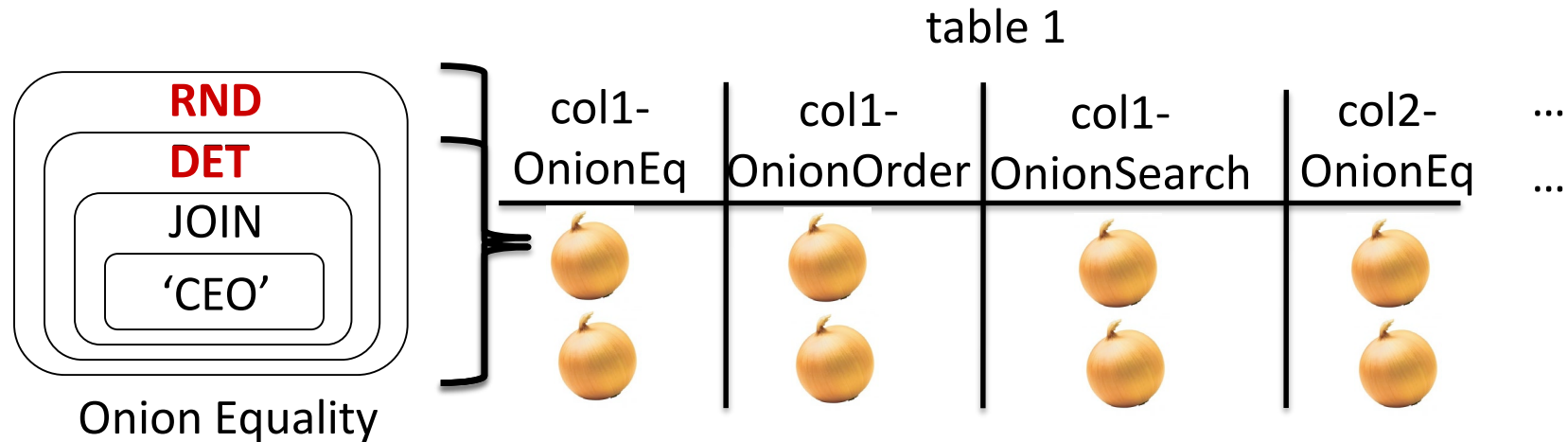

SELECT * FROM emp WHERE rank = 'CEO'



UPDATE table1 SET col1-OnionEq =

Decrypt_RND(key, col1-OnionEq)

SELECT * FROM table1 WHERE col1-OnionEq = xda5c0407

Security threshold

Data owner can specify minimum level of security

```
CREATE TABLE emp (... , credit_card SENSITIVE integer, ...)
```



RND, HOM, DET for unique fields
≈ semantic security

Security guarantee

Columns annotated as sensitive have semantic security (or similar).

Encryption schemes exposed for each column are the most secure enabling queries.

equality → repeats

sum → semantic

no filter → semantic

common in practice

 **Never reveals plaintext**

<http://www.cs.cornell.edu/courses/cs5412/2020sp>

Limitations & Workarounds

Queries not supported:

- More complex operators, e.g., trigonometry
- Certain combinations of encryption schemes:
 - e.g., salary + raise > 100K

HOM

 use query splitting, query rewriting

Implementation

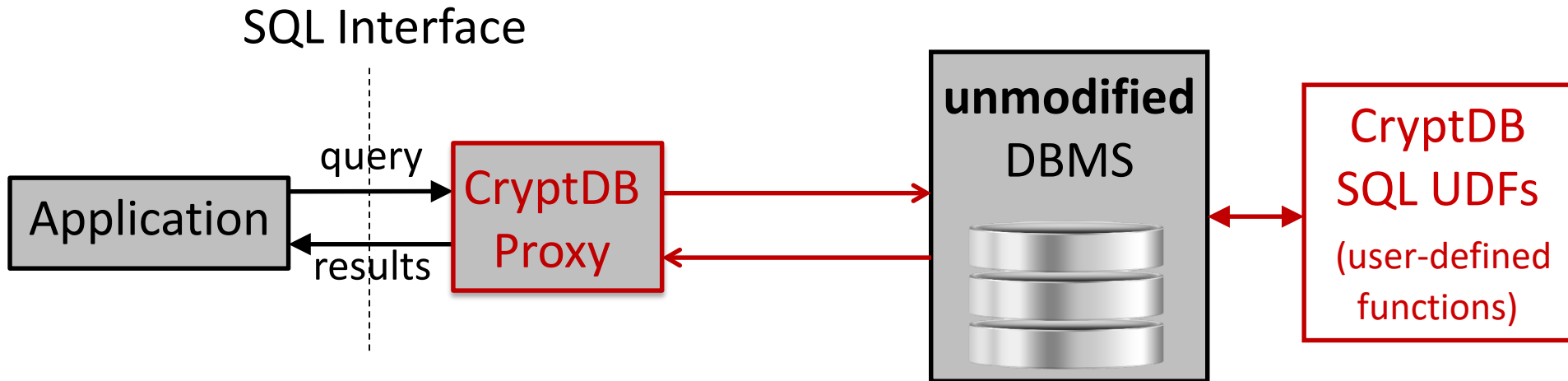

No change to the DBMS!

Largely no change to apps!

Evaluation

1. Does it support real queries/applications?
2. What is the resulting confidentiality level?
3. What is the performance overhead?

Real queries/applications

Application	Encrypted columns	# cols with queries not supported
phpBB	23	0
HotCRP	22	0
grad-apply	103	0
TPC-C	92	0
sql.mit.edu	128,840	1,094

apps with sensitive columns

tens of thousands of apps

SELECT 1/log(series_no+1.2) ...
... WHERE sin(latitude + PI()) ...

Confidentiality level

Final onion state

Application	Encrypted columns	Min level: ≈semantic	Min level: DET/JOIN	Min level: OPE
phpBB	23	21	1	1
HotCRP	22	18	1	2
grad-apply	103	95	6	2
TPC-C	92	65	19	8
sql.mit.edu	128,840	80,053	34,212	13,131

Most columns at semantic

Most columns at OPE were less sensitive

Performance

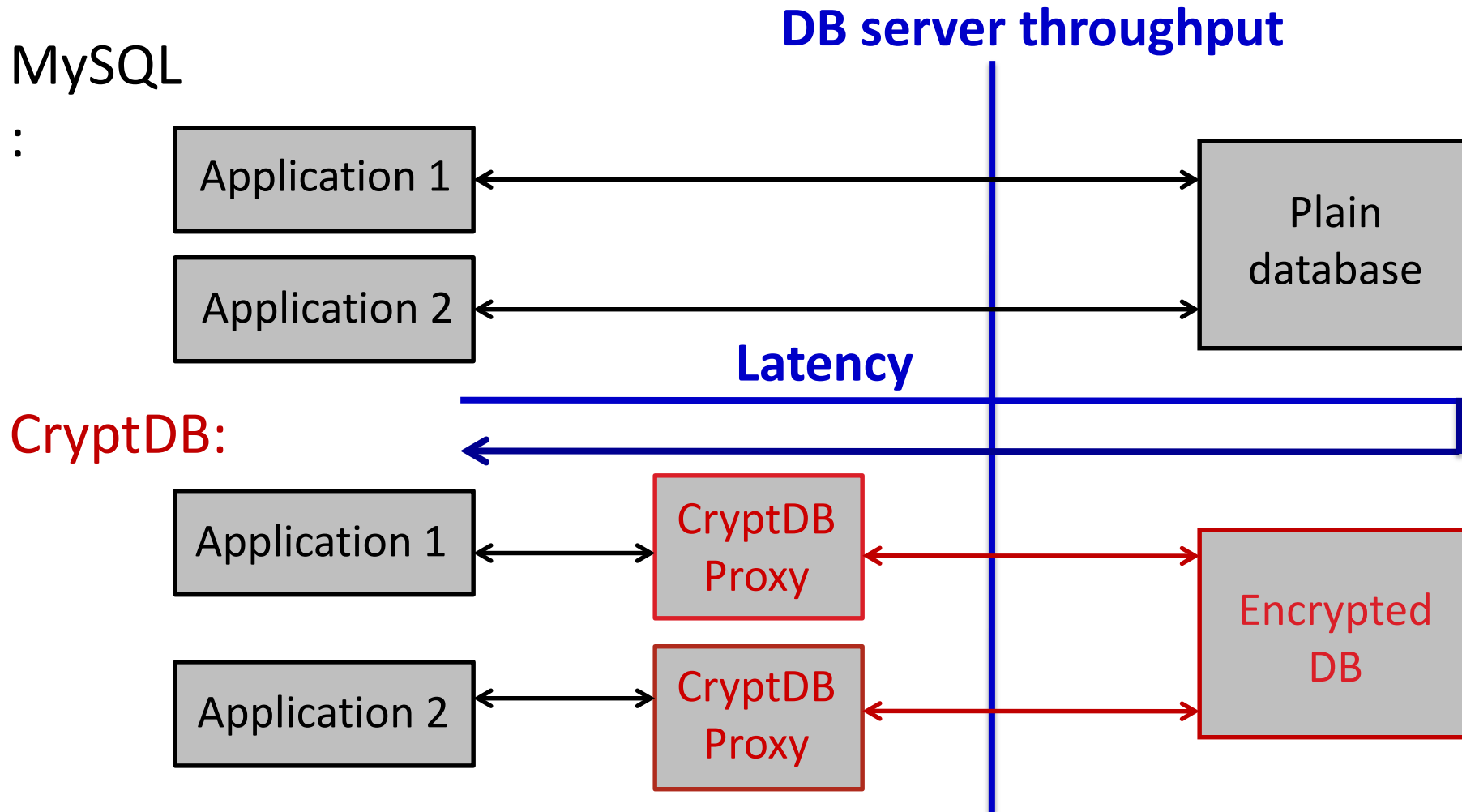

Hardware: 2.4 GHz Intel Xeon E5620 – 8 cores, 12 GB RAM

TPC-C performance

Latency (per query): 0.10ms MySQL vs. 0.72ms CryptDB

Throughput loss over MySQL: 26%

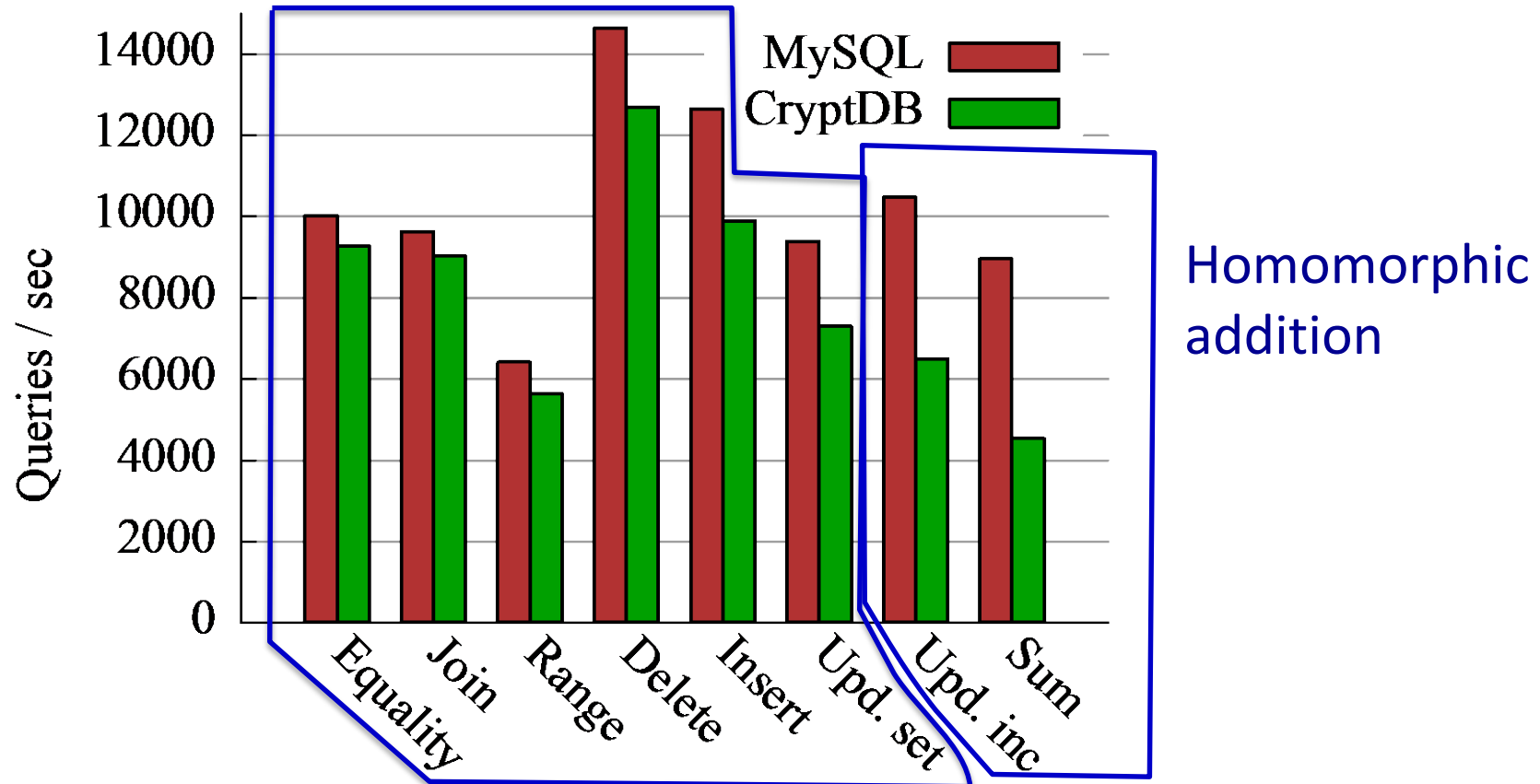

No cryptography at the DB server in the steady state!

Adoption

<http://css.csail.mit.edu/cryptdb/>

Google



Úlfar Erlingsson,
head of security
research, Google

Encrypted BigQuery [\[http://code.google.com/p/encrypted-bigquery-client/\]](http://code.google.com/p/encrypted-bigquery-client/)

“CryptDB was really eye-opening in establishing the practicality of providing a SQL-like query interface to an encrypted database”

“CryptDB was [...] directly influential on the design and implementation of Encrypted BigQuery.”



SEED implemented on top of the SAP HANA DBMS



Encrypted version of the D4M Accumulo NoSQL engine

sql.mit.edu

Users opted-in to run Wordpress over our CryptDB source code

<http://www.cs.cornell.edu/courses/cs5412/2020sp>

CONCERNS ABOUT CRYPTDB?

The main criticisms stem from the “strip a layer” step.

Once we reduce the level of protection, we’ve leaked some information and the remaining data is “less protected”. Raluca’s response: if you want to make use of operations like aggregation, you can’t easily avoid releasing some information.

Criticism response to Raluca: attacker might trick my code into doing the operation, and might do so in the future when some flaw in one of the crypto scheme is noticed. The logic wouldn’t protect itself in that case.

SUMMARY

A “leave no trace” model could offer a practical way to leverage the cloud and yet not release private data to the public.

With a trusted vendor willing to audit operations and to “enclave” sensitive data computation, and clean up afterward, there is real hope for privacy without leaks.

SGX, costly but can be used where the vendor is not trusted.

For databases, techniques like CryptDB aren’t perfect but work well. Differential privacy is even better, but only if noise can be tolerated.