

What does the Future Hold?

Hakim Weatherspoon

CS 3410, Spring 2012

Computer Science

Cornell University

Announcements

Prelim3 Results

- Mean 62.2 ± 15.5 (median 64.5), Max 97
- Pickup in Homework Passback Room

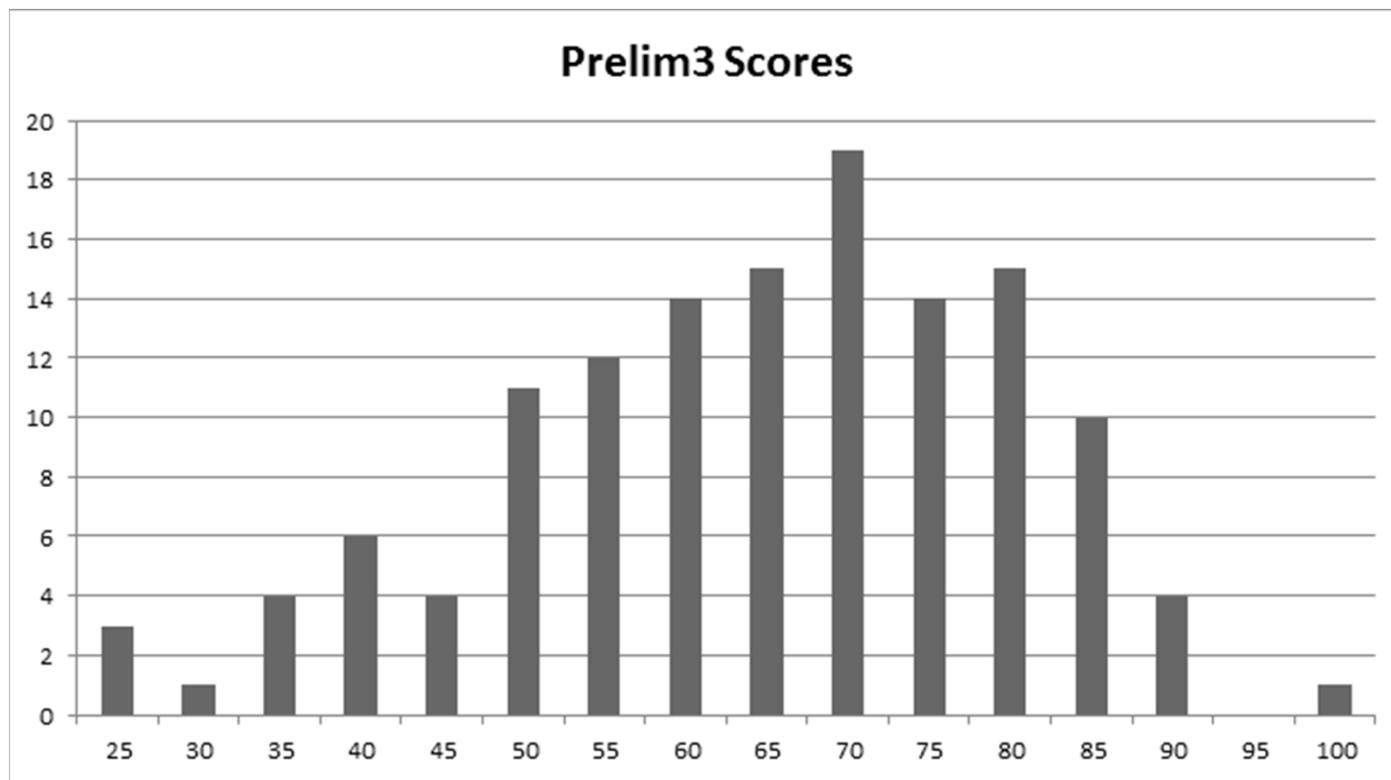

Announcements

How to improve your grade?

Submit a course evaluation and drop lowest homework score

- To receive credit, Submit before Monday, May 7th

Announcement

FlameWar Pizza Party was great!

- Winner: Team ***MakeTotalDestroy***
Kenny Deakins and Luis Ruigomez

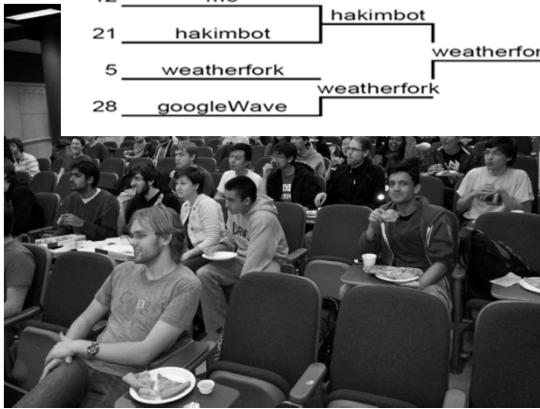
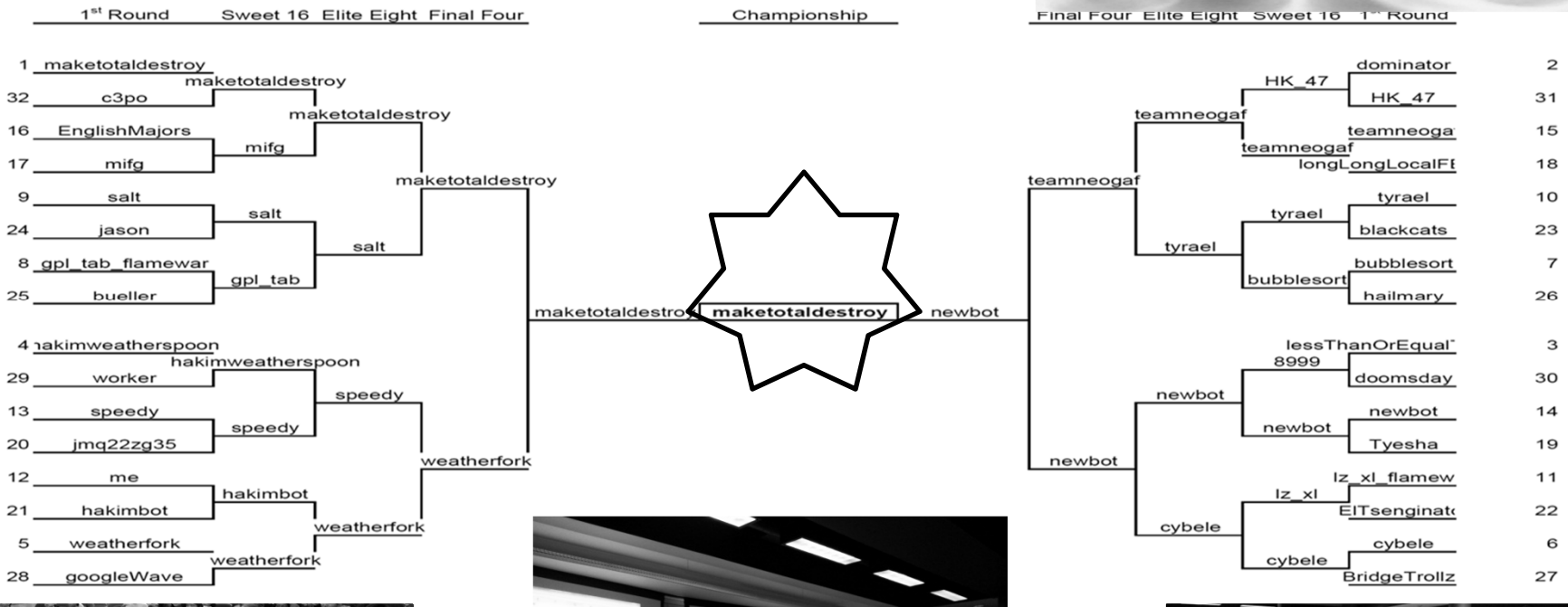

Announcements

Final Project

Design Doc sign-up via CMS

sign up Sunday, Monday, or Tuesday

May 6th, 7th, or 8th

Demo Sign-Up via CMS.

sign up Tuesday, May 15th

or Wednesday, May 16th

CMS submission due:

- Due 6:30pm Wednesday, May 16th

Big Picture about the Future

Big Picture

How a processor works? How a computer is organized?

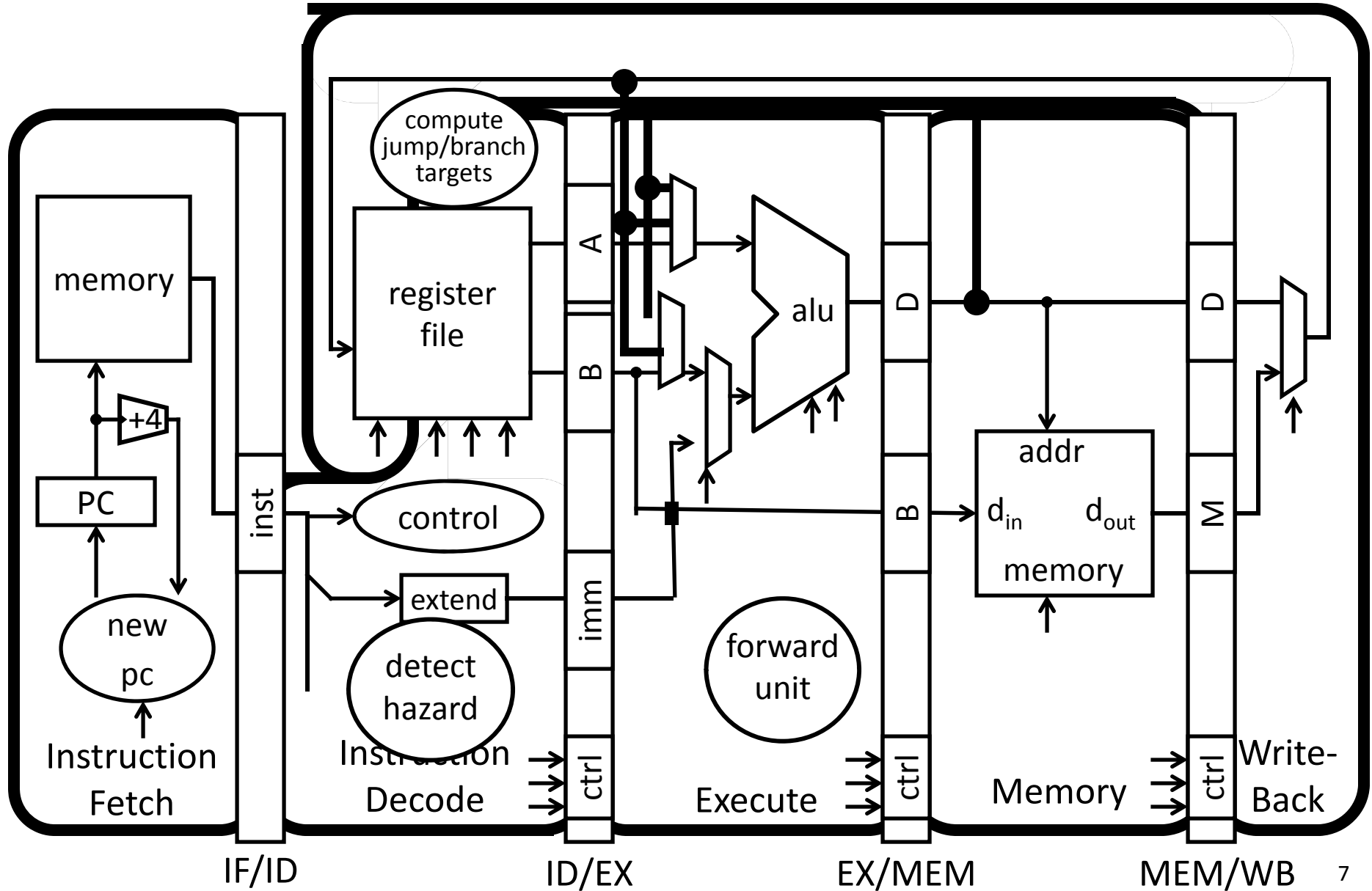

What's next?

More of Moore

Moore's Law

Moore's Law introduced in 1965

- Number of transistors that can be integrated on a single die would double every 18 to 24 months (i.e., grow exponentially with time).

Amazingly visionary

- 2300 transistors, 1 MHz clock (Intel 4004) - 1971
- 16 Million transistors (Ultra Sparc III)
- 42 Million transistors, 2 GHz clock (Intel Xeon) – 2001
- 55 Million transistors, 3 GHz, 130nm technology, 250mm² die (Intel Pentium 4) – 2004
- 290+ Million transistors, 3 GHz (Intel Core 2 Duo) – 2007
- 731 Million transistors, 2-3Ghz (Intel Nehalem) – 2009
- 1.17 Billion transistors, 2-3Ghz (Intel Westmere) – 2011 ⁹

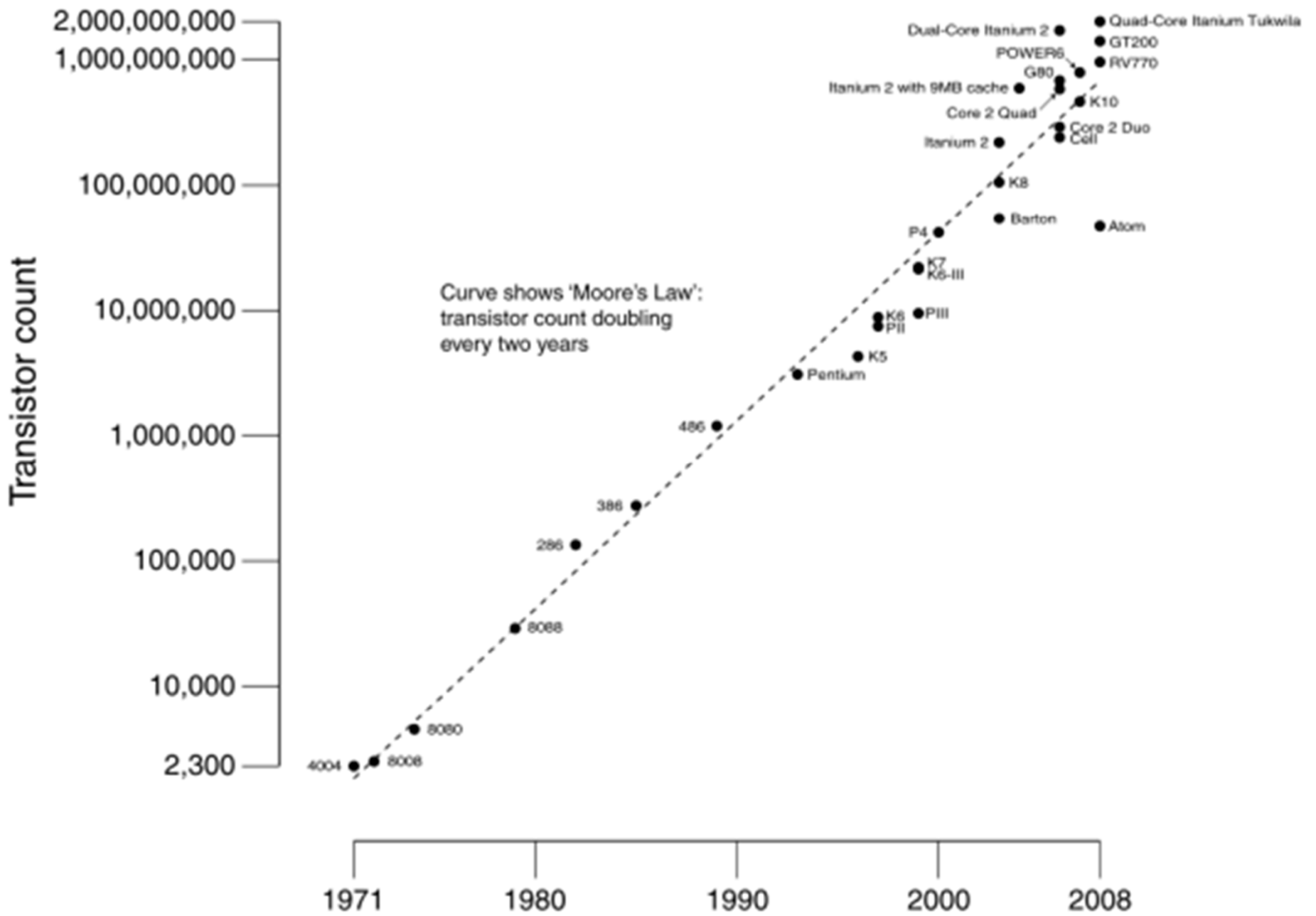

Power Limits

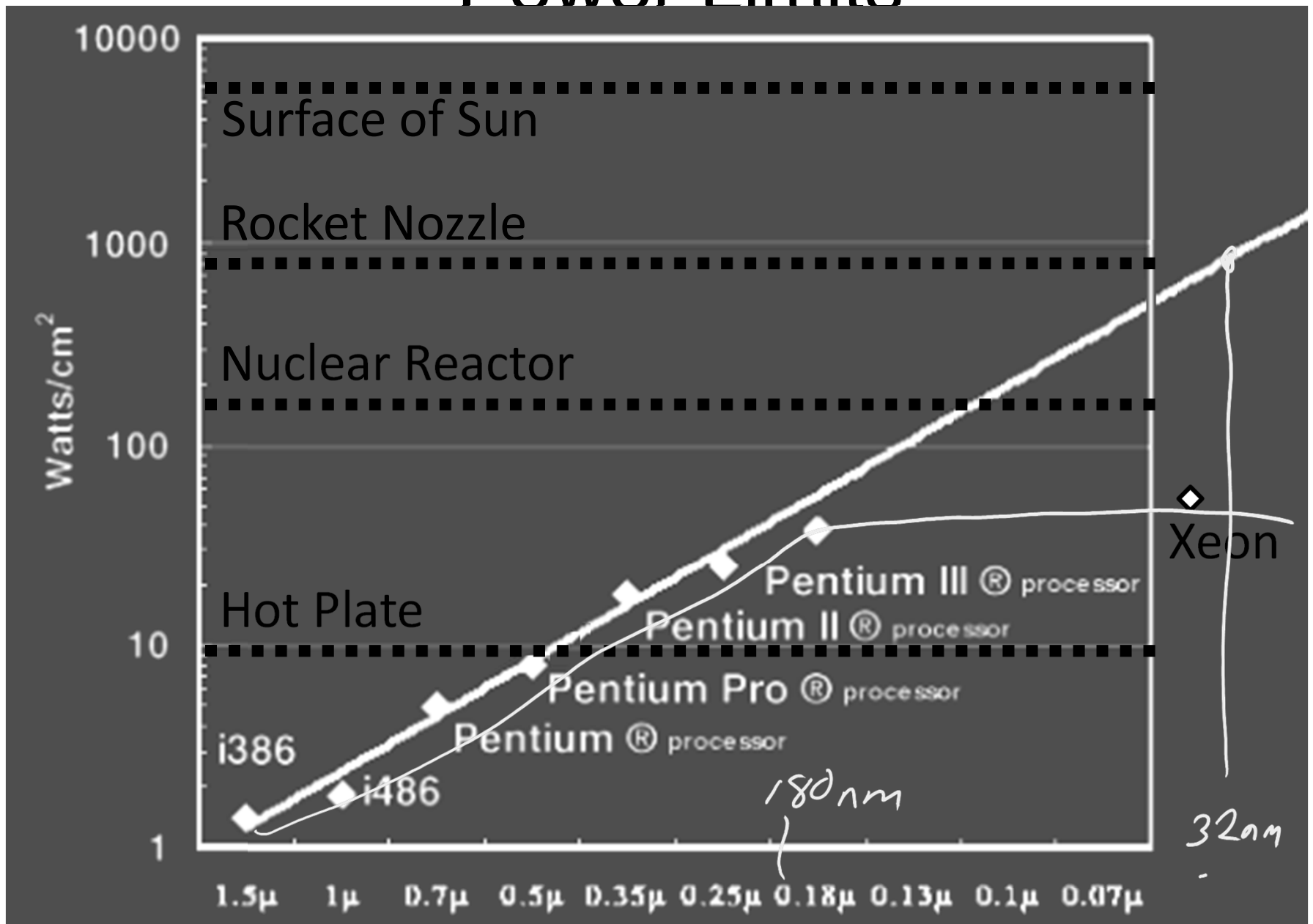

What to do with all these transistors?

Multi-core

Multi-core

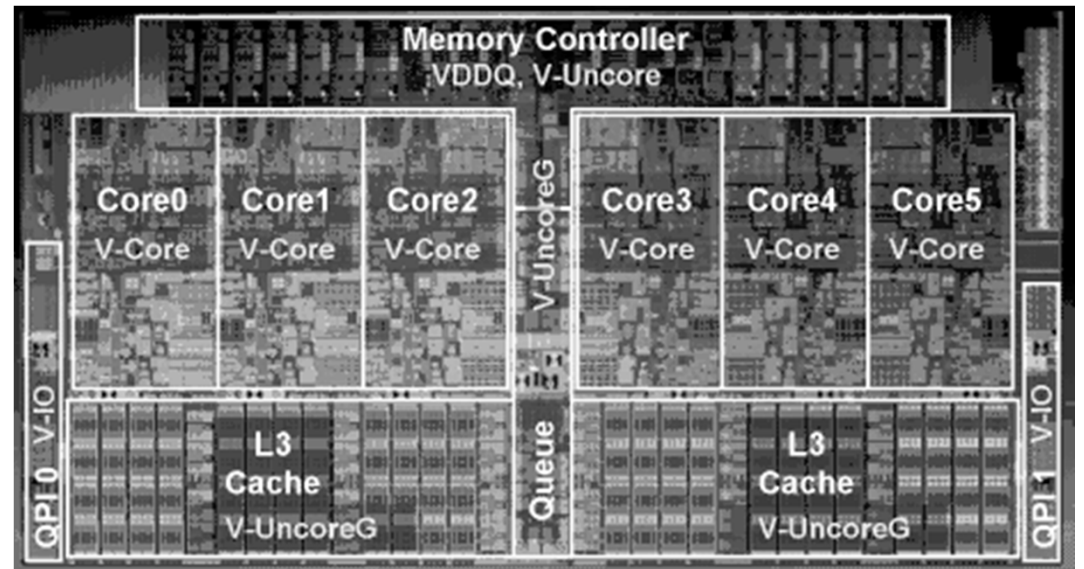
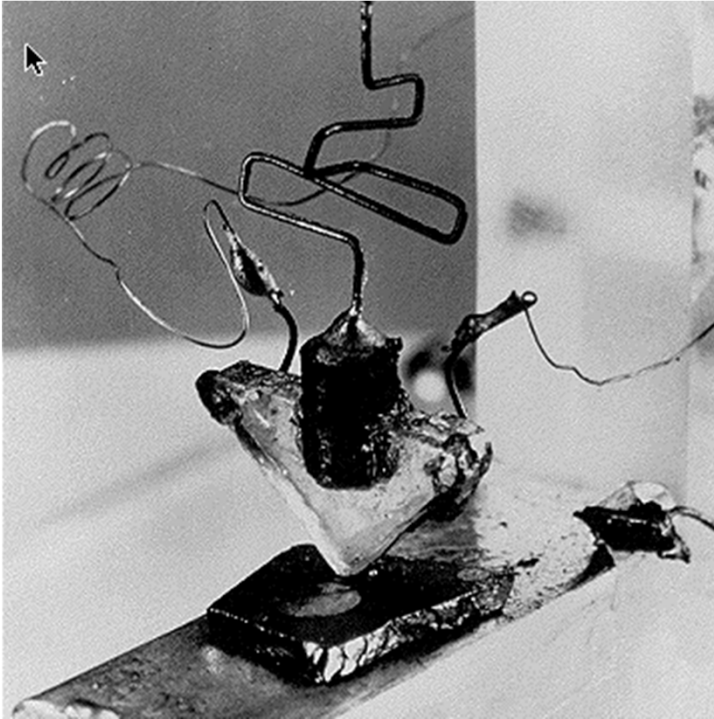

http://www.theregister.co.uk/2010/02/03/intel_westmere_ep_preview/

The first transistor

- on a workbench at AT&T Bell Labs in 1947
- Bardeen, Brattain, and Shockley

- An Intel Westmere
 - 1.17 billion transistors
 - 240 square millimeters
 - Six processing cores

What to do with all these transistors?

Many-core
and Graphical Processing units

Faster than Moore's Law

One-pixel polygons (~10M polygons @ 30Hz)

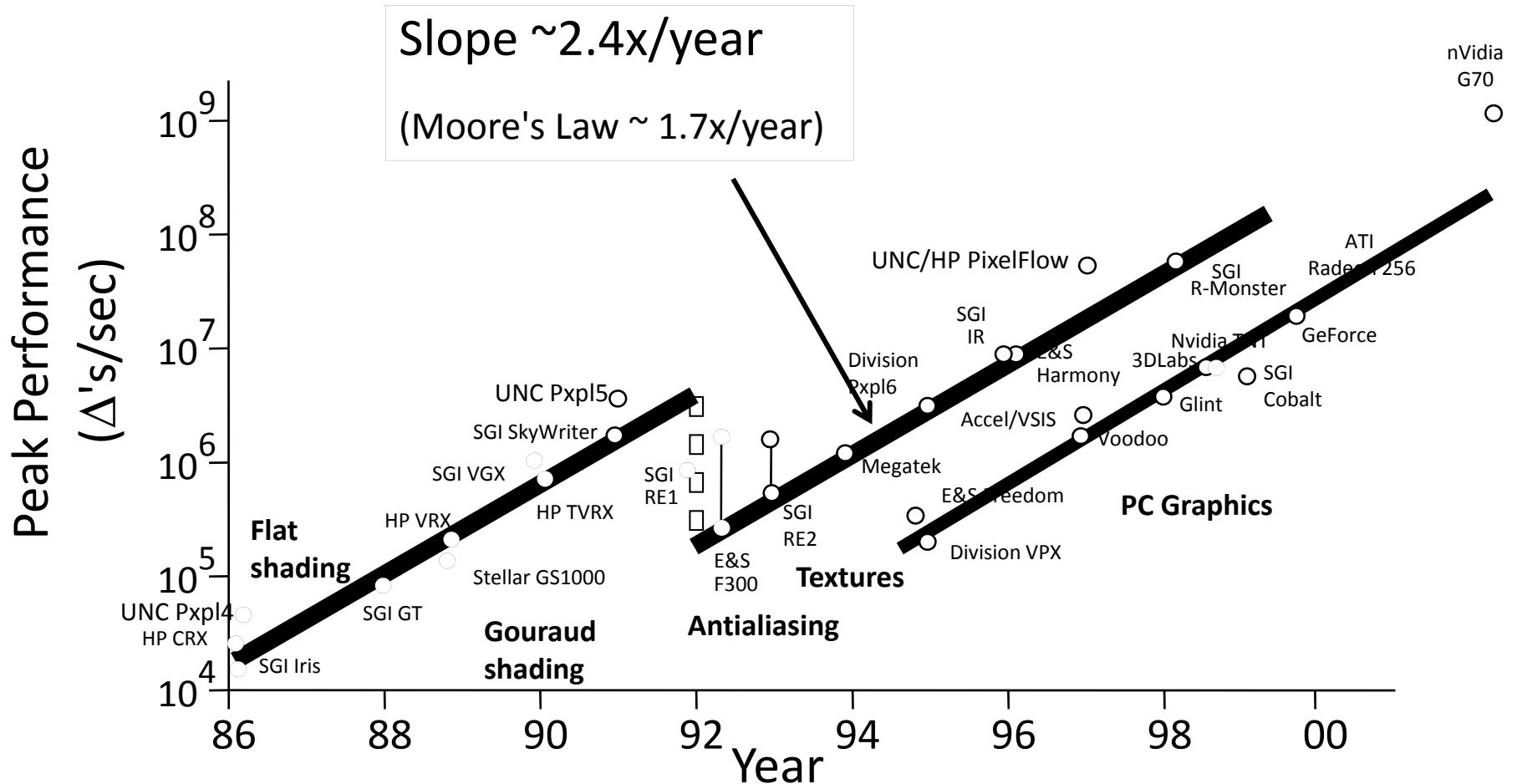

Graph courtesy of Professor John Poulton (from Eric Haines)

AMDs Hybrid CPU/GPU

AMD's Answer: Hybrid CPU/GPU

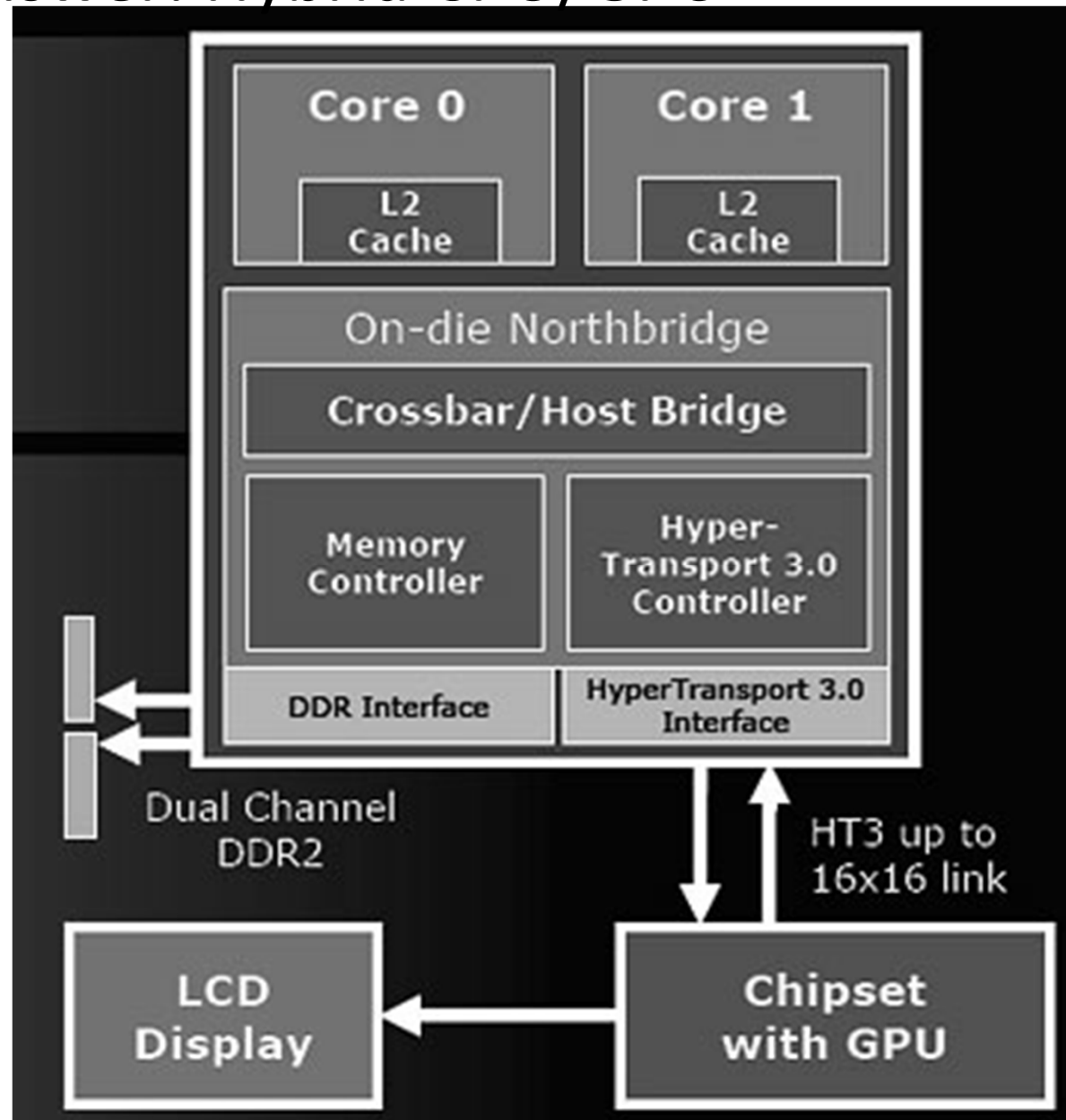

IBM/Sony/Toshiba

Sony Playstation 3

PPE

SPEs (synergistic)

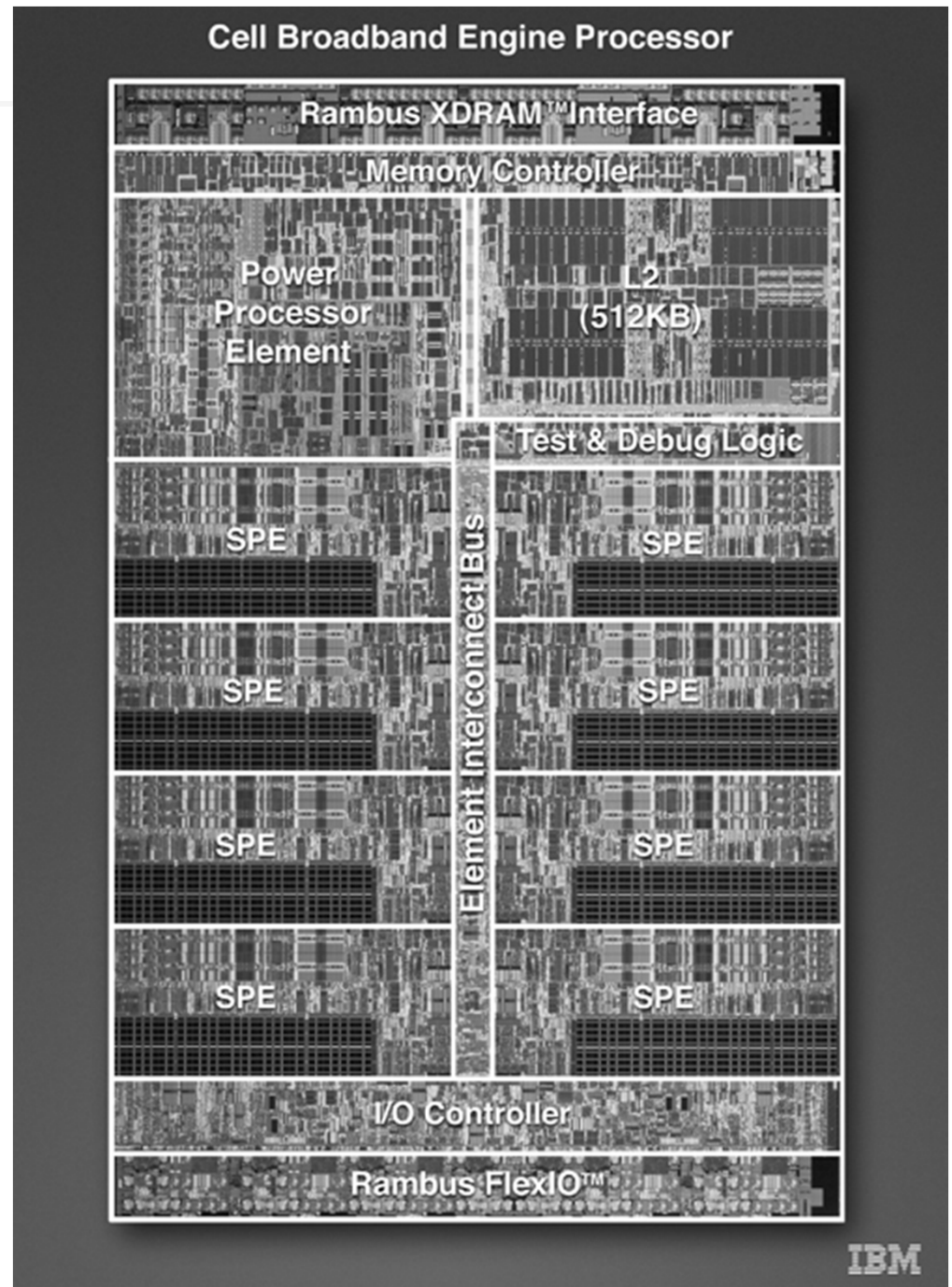

Parallelism

Must exploit parallelism for performance

- Lots of parallelism in graphics applications
- Lots of parallelism in scientific computing

SIMD: single instruction, multiple data

- Perform same operation in parallel on many data items
- Data parallelism

MIMD: multiple instruction, multiple data

- Run separate programs in parallel (on different data)
- Task parallelism

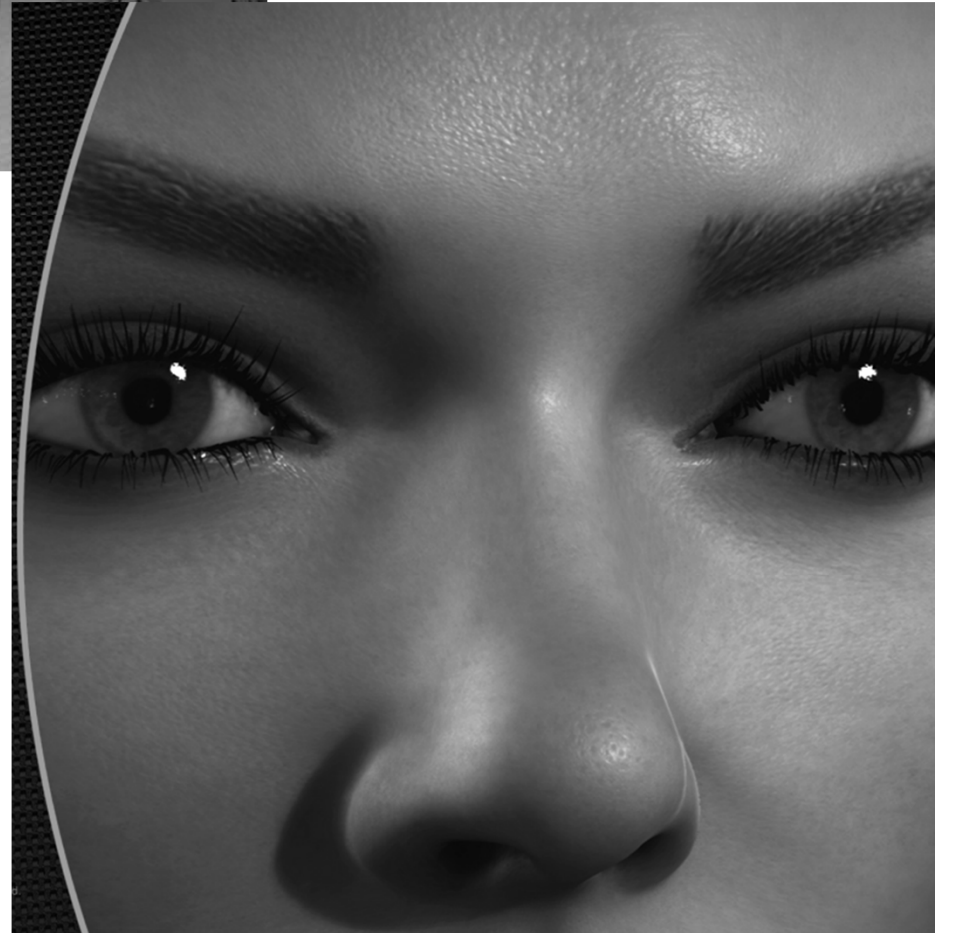

NVIDIA Tesla Architecture



Why are GPUs so fast?

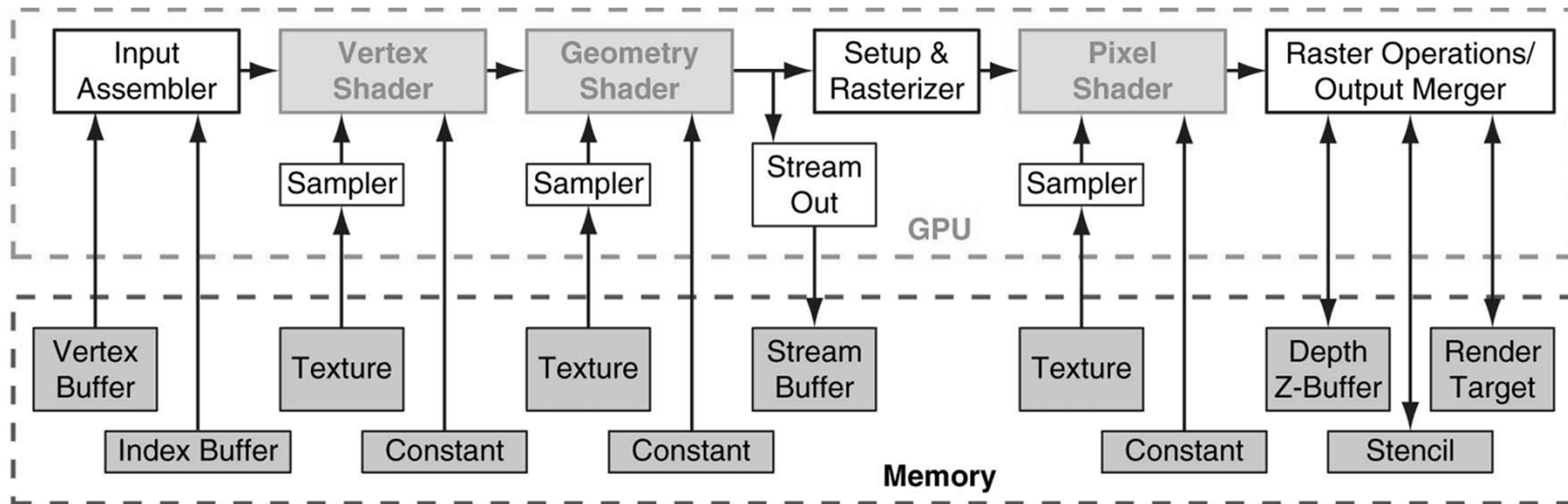

FIGURE A.3.1 Direct3D 10 graphics pipeline. Each logical pipeline stage maps to GPU hardware or to a GPU processor. Programmable shader stages are blue, fixed-function blocks are white, and memory objects are grey. Each stage processes a vertex, geometric primitive, or pixel in a streaming dataflow fashion. Copyright © 2009 Elsevier, Inc. All rights reserved.

Pipelined and parallel

Very, very parallel: 128 to 1000 cores

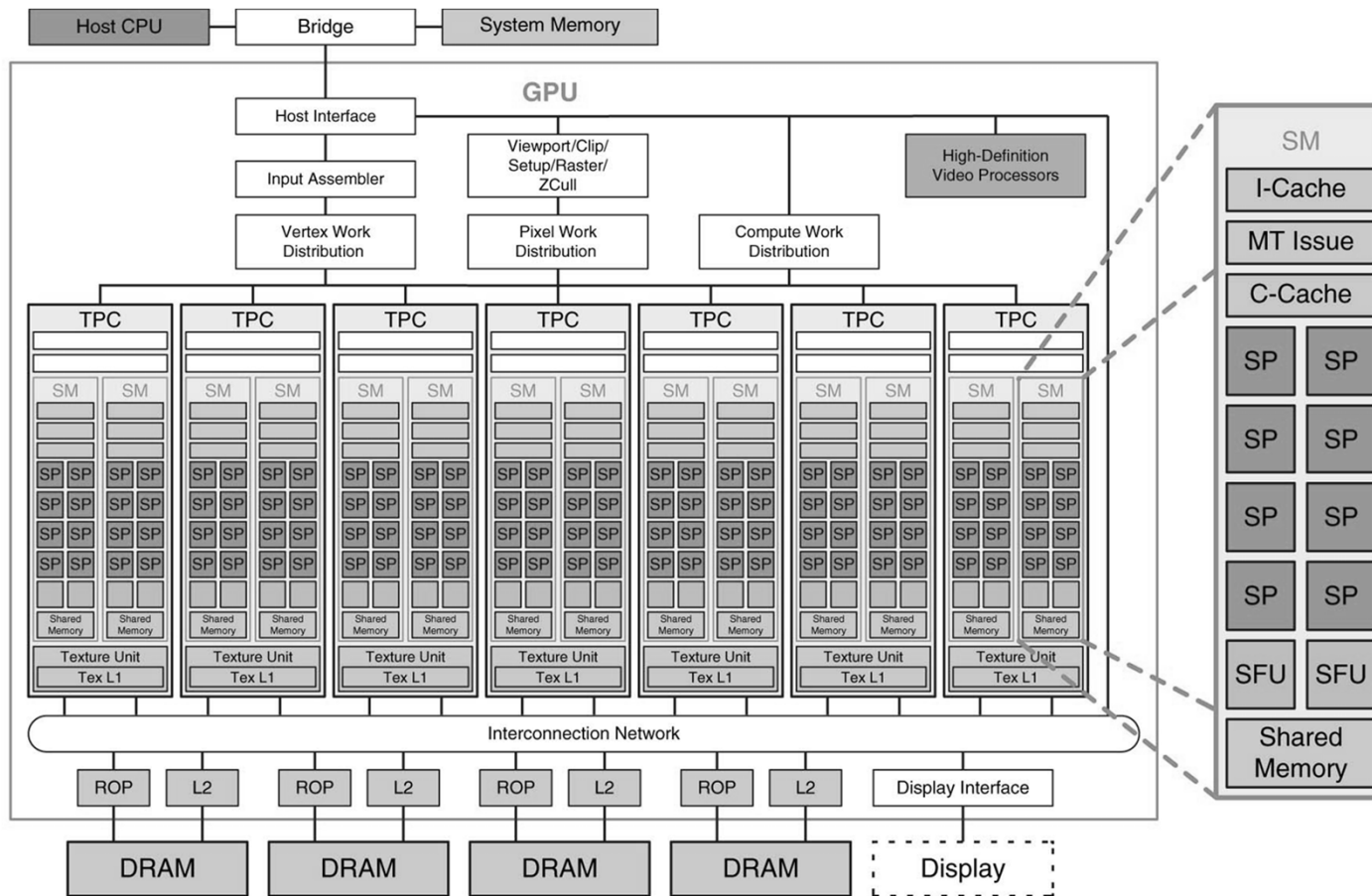

FIGURE A.2.5 Basic unified GPU architecture. Example GPU with 112 streaming processor (SP) cores organized in 14 streaming multiprocessors (SMs); the cores are highly multithreaded. It has the basic Tesla architecture of an NVIDIA GeForce 8800. The processors connect with four 64-bit-wide DRAM partitions via an interconnection network. Each SM has eight SP cores, two special function units (SFUs), instruction and constant caches, a multithreaded instruction unit, and a shared memory. Copyright © 2009 Elsevier, Inc. All rights reserved.

General computing with GPUs

Can we use these for general computation?

Scientific Computing

- MATLAB codes

Convex hulls

Molecular Dynamics

Etc.

NVIDIA's answer:

Compute Unified Device Architecture (CUDA)

- MATLAB/Fortran/etc. → “C for CUDA” → GPU Codes

What to do with all these transistors?

Cloud Computing

Cloud Computing

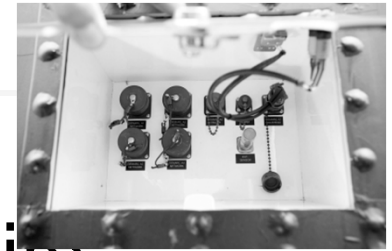

Datacenters are becoming a commodity

Order online and have it delivered

- Datacenter in a box: already set up with commodity hardware & software (Intel, Linux, petabyte of storage)
- Plug data, power & cooling and turn on



such datacenters



Cloud Computing = Network of Datacenters



Cloud Computing

Enable datacenters to coordinate over vast distances

- Optimize availability, disaster tolerance, energy
- Without sacrificing performance
- “cloud computing”

Drive underlying technological innovations.



Vision Cloud Computing

The promise of the Cloud

- A computer utility; a commodity
- Catalyst for technology economy
- Revolutionizing for health care, financial systems, scientific research, and society

However, cloud platforms today

- Entail significant risk: vendor lock-in vs control
- Entail inefficient processes: energy vs performance
- Entail poor communication: fiber optics vs COTS endpoints

Example: Energy and Performance

Why don't we save more energy in the cloud?

No one deletes data anymore!

- Huge amounts of seldom-accessed data

Data deluge

- Google (YouTube, Picasa, Gmail, Docs), Facebook, Flickr
- 100 GB per second is faster than hard disk capacity growth!
- Max amount of data accessible at one time \ll Total data

New scalable approach needed to store this data

- Energy footprint proportional to number of HDDs is *not* sustainable

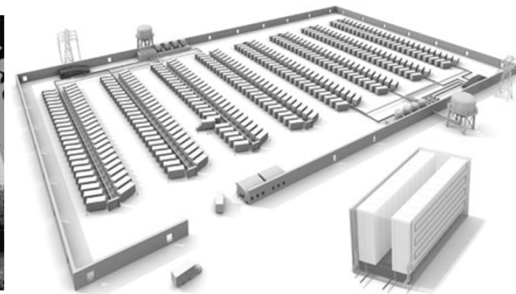

What to do with all these transistors?

Embedded Processors

Where is the Market?

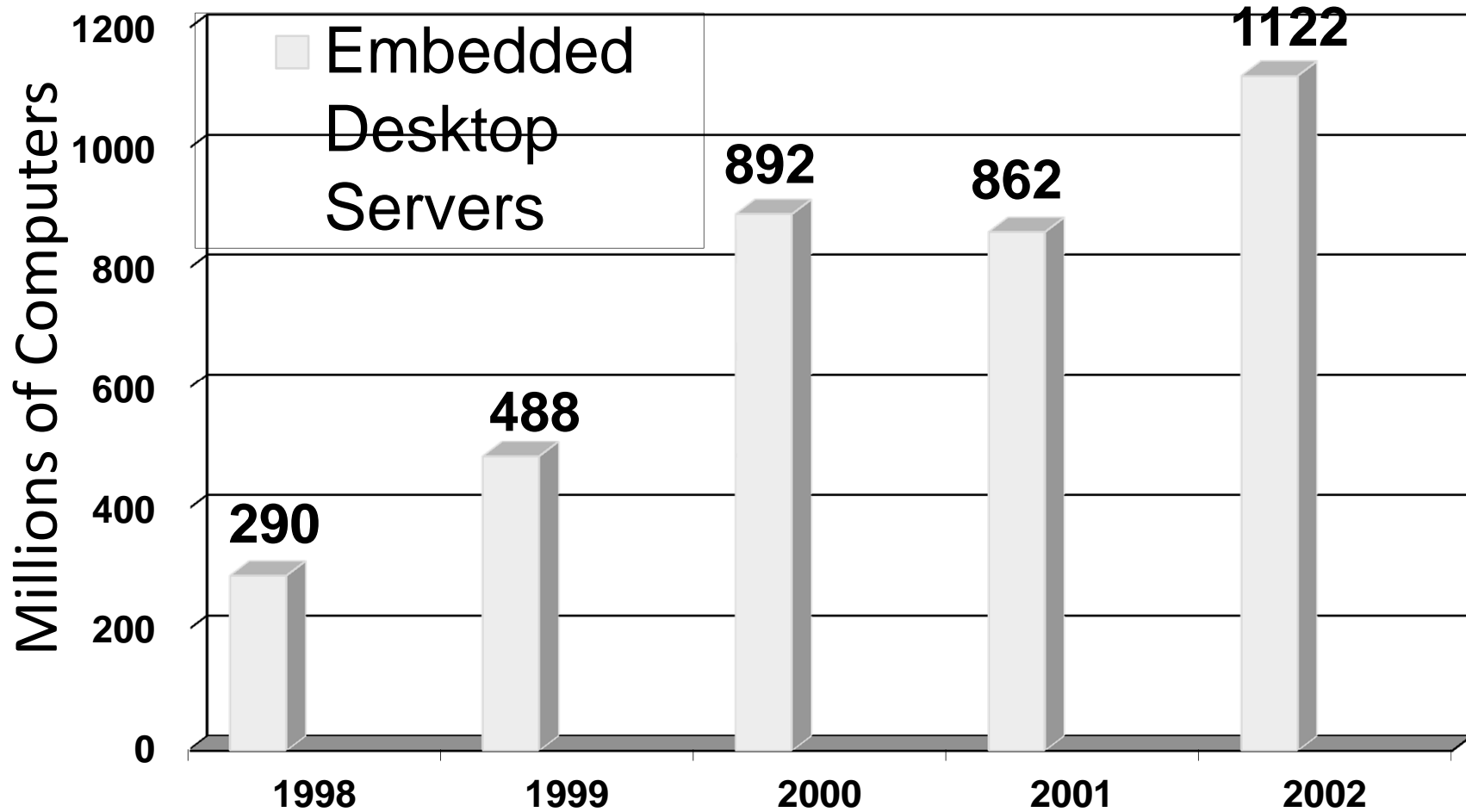

Where is the Market?

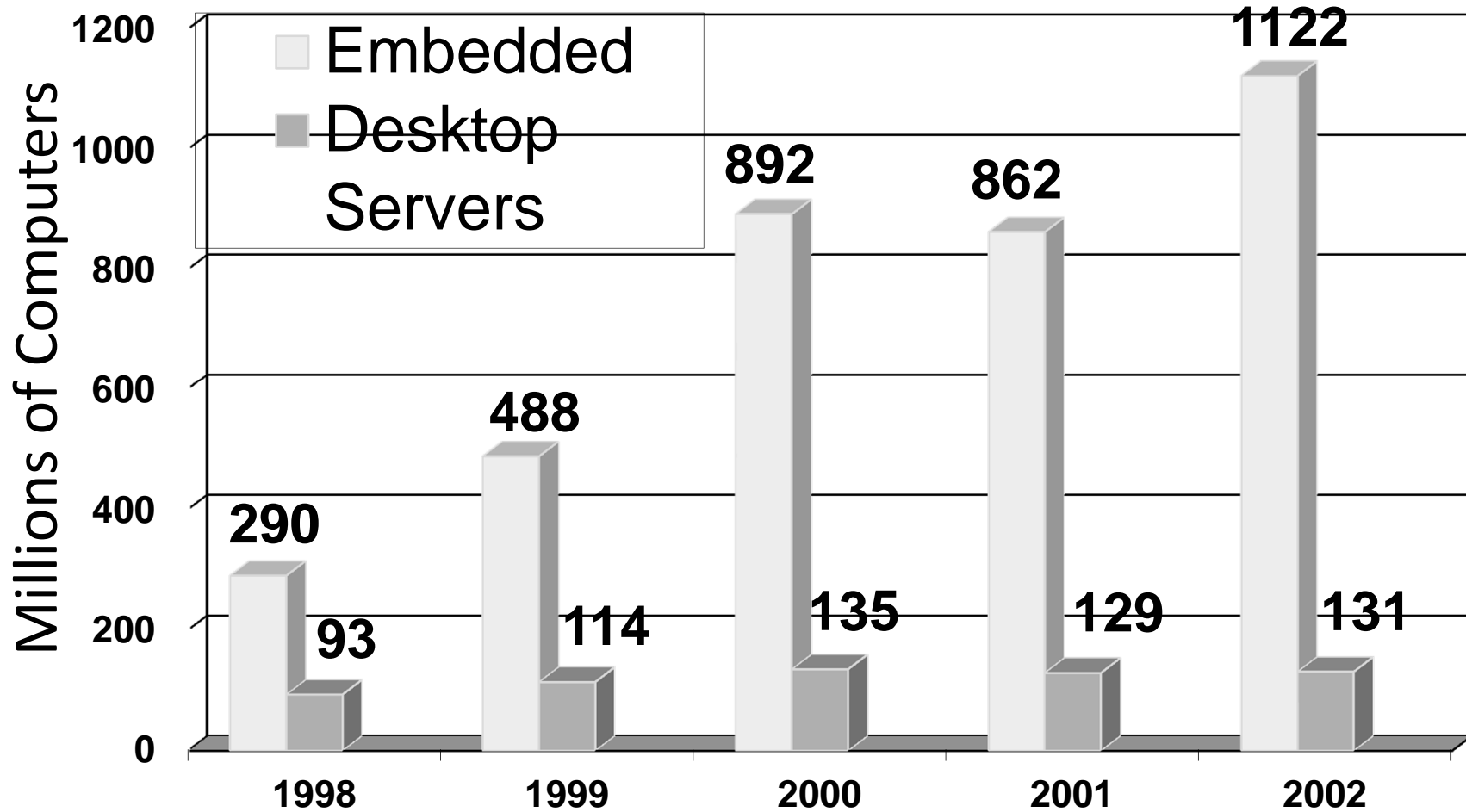

Where is the Market?

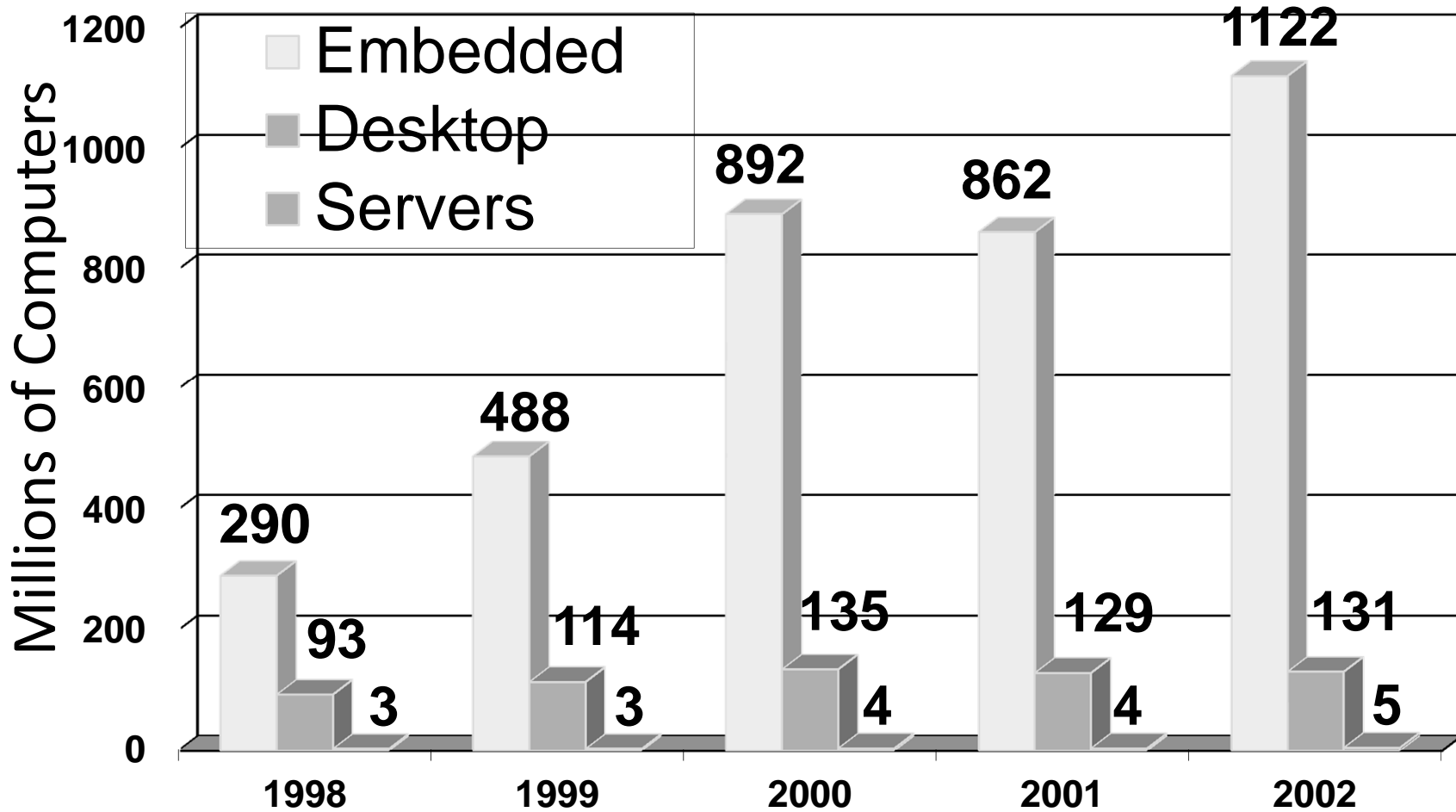

Where is the Market?

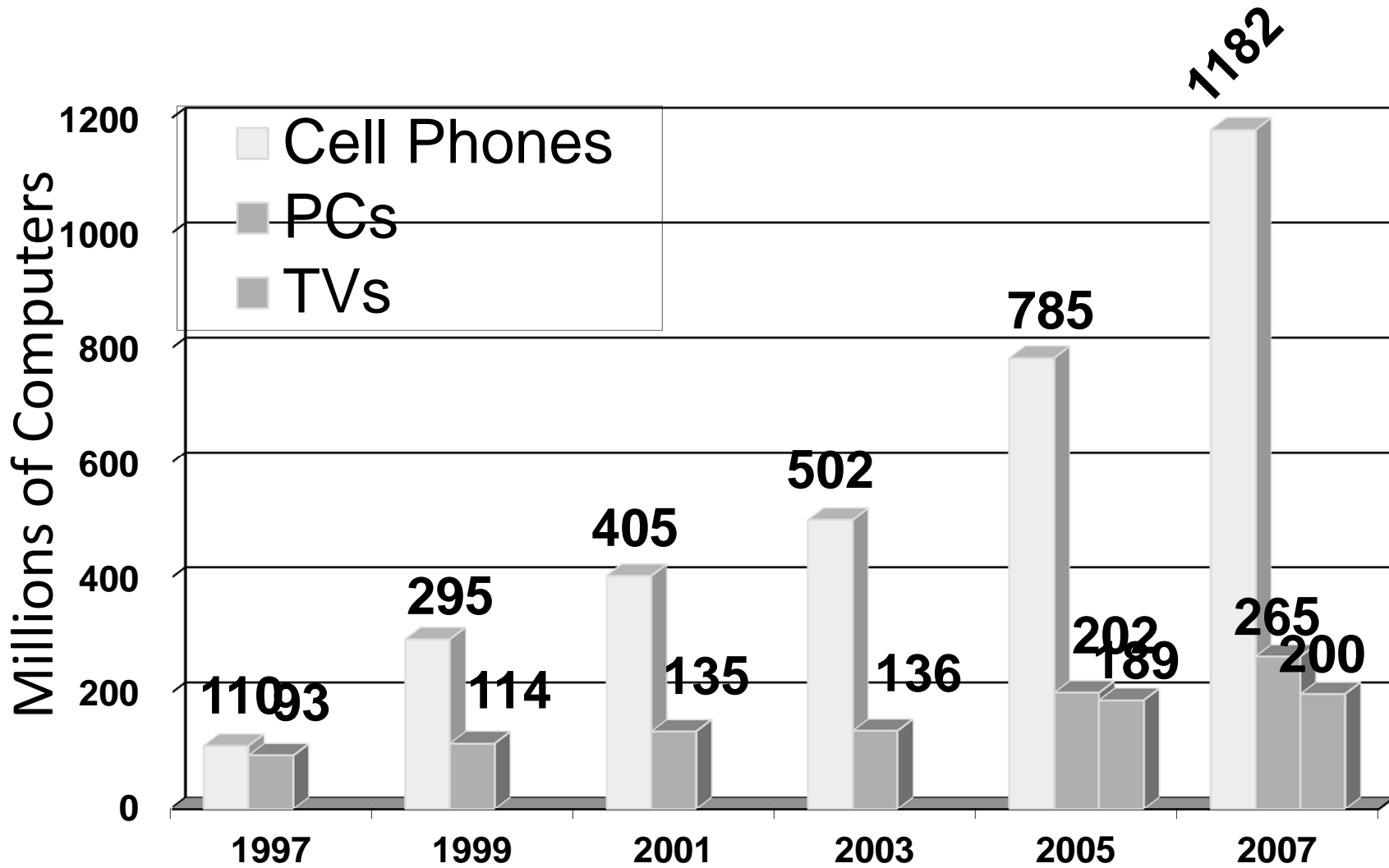



Where to?

Src

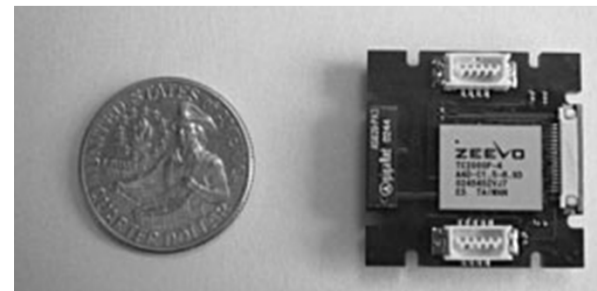
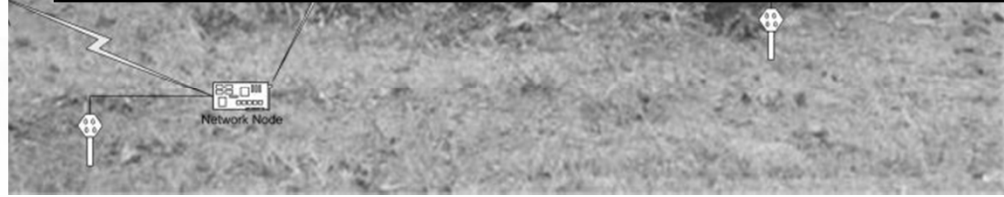
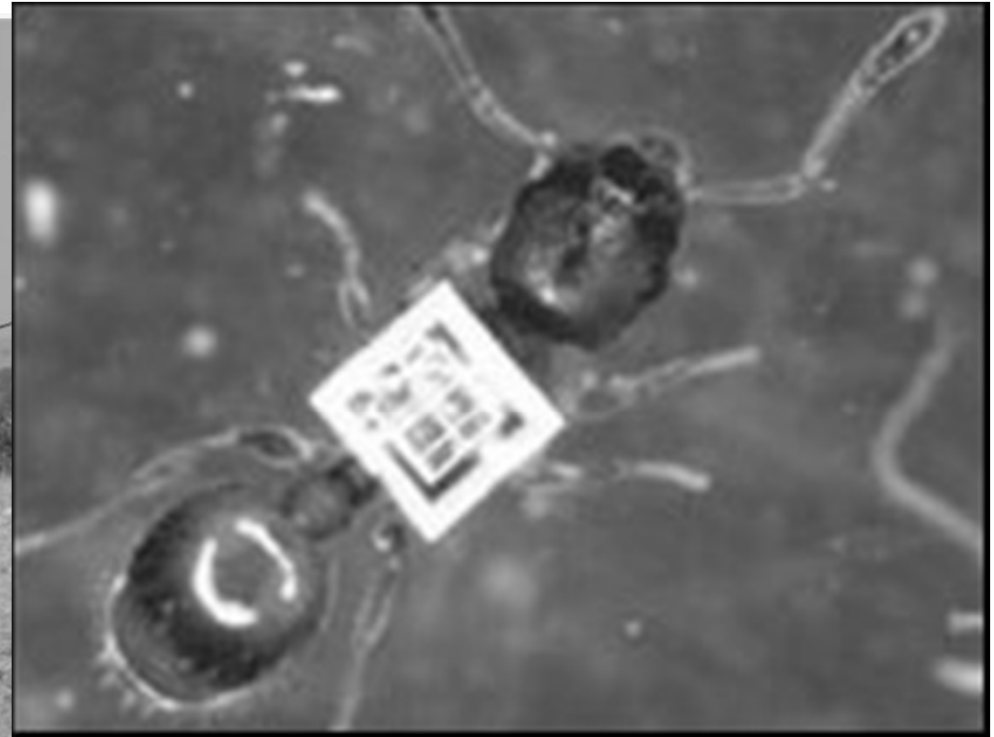
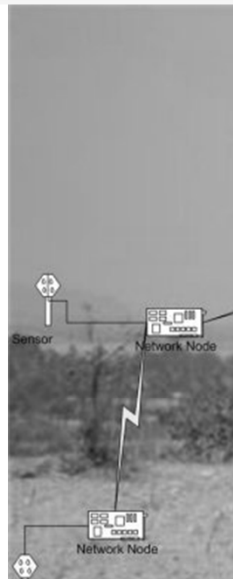

Security?

Cryptography and security...

TPM 1.2

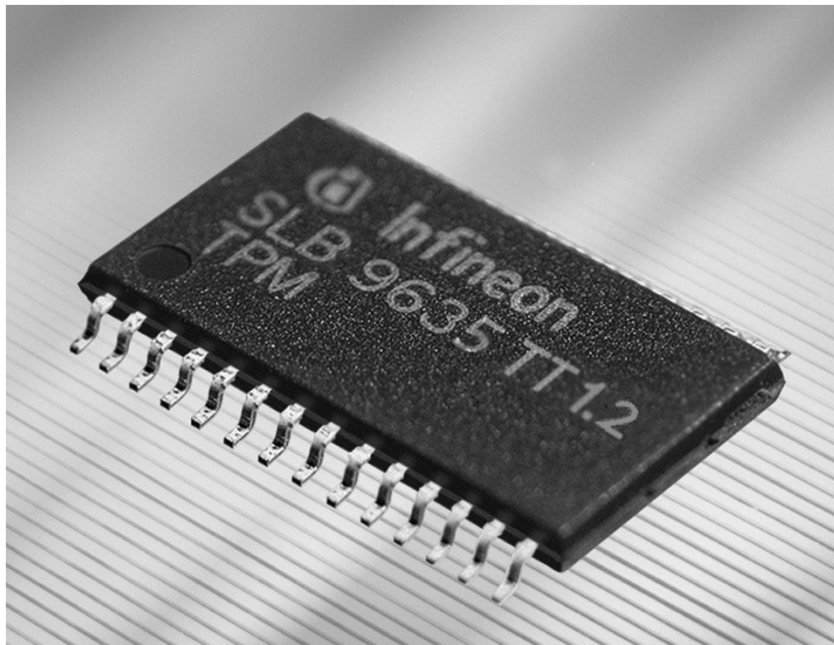

IBM 4758
Secure Cryptoprocessor

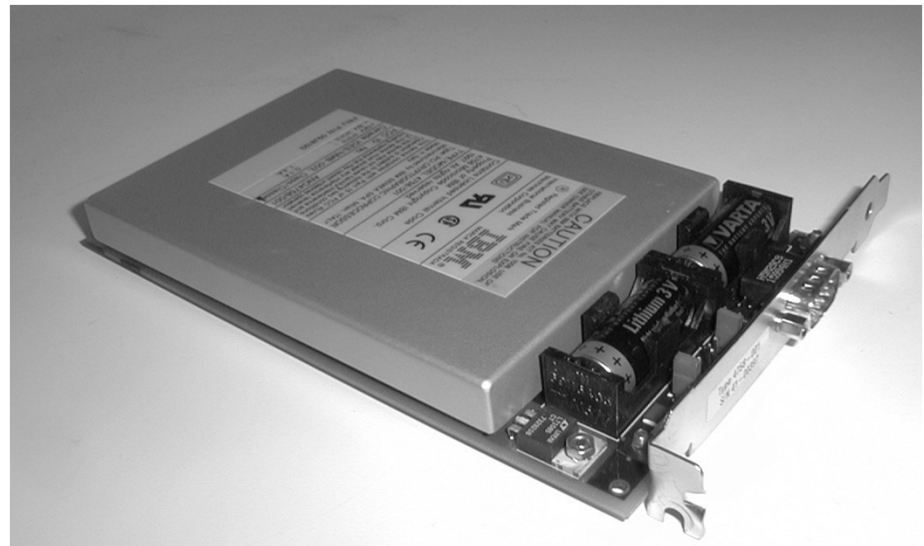

Security?

Smart Cards...



What to do with all these transistors?

You could save the world one day?

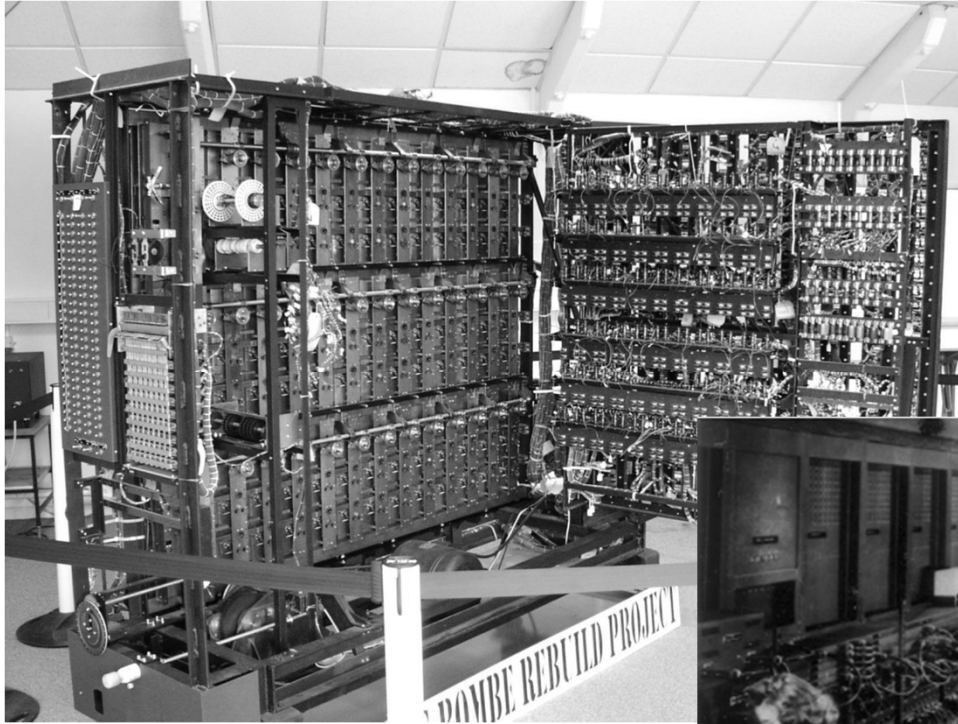

Alan Turing's Bombe
Used to crack Germany's
enigma machine

ENIAC - 1946

First general purpose
electronic computer. Designed
to calculate ballistic trajectories

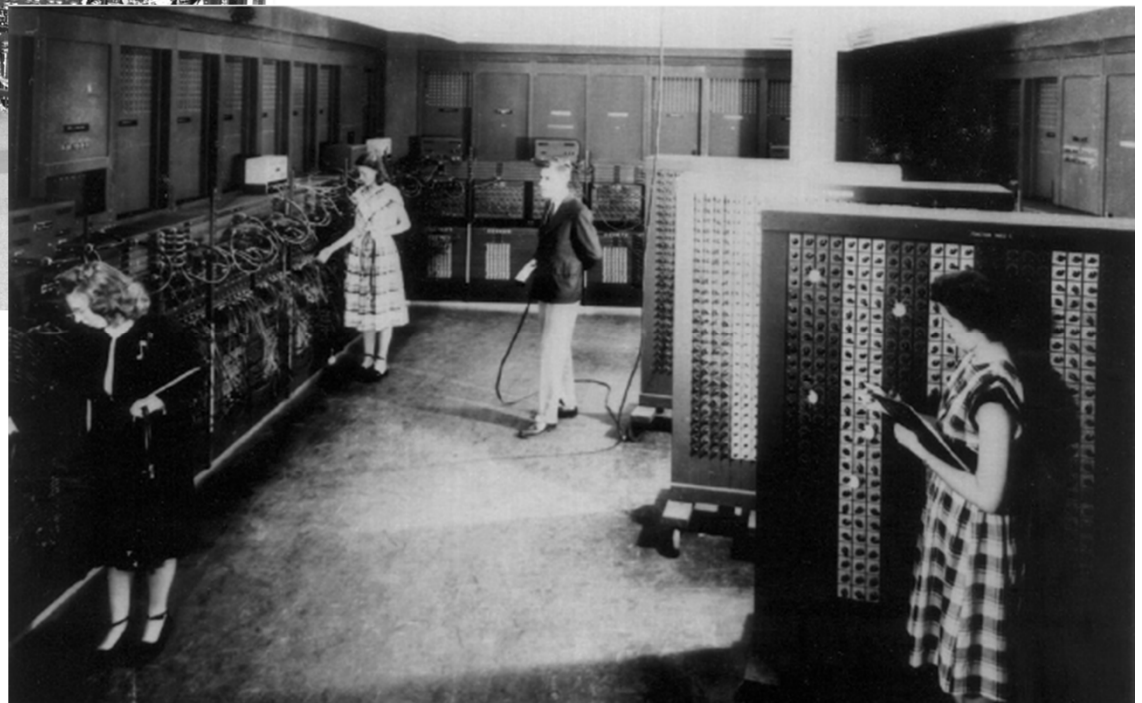

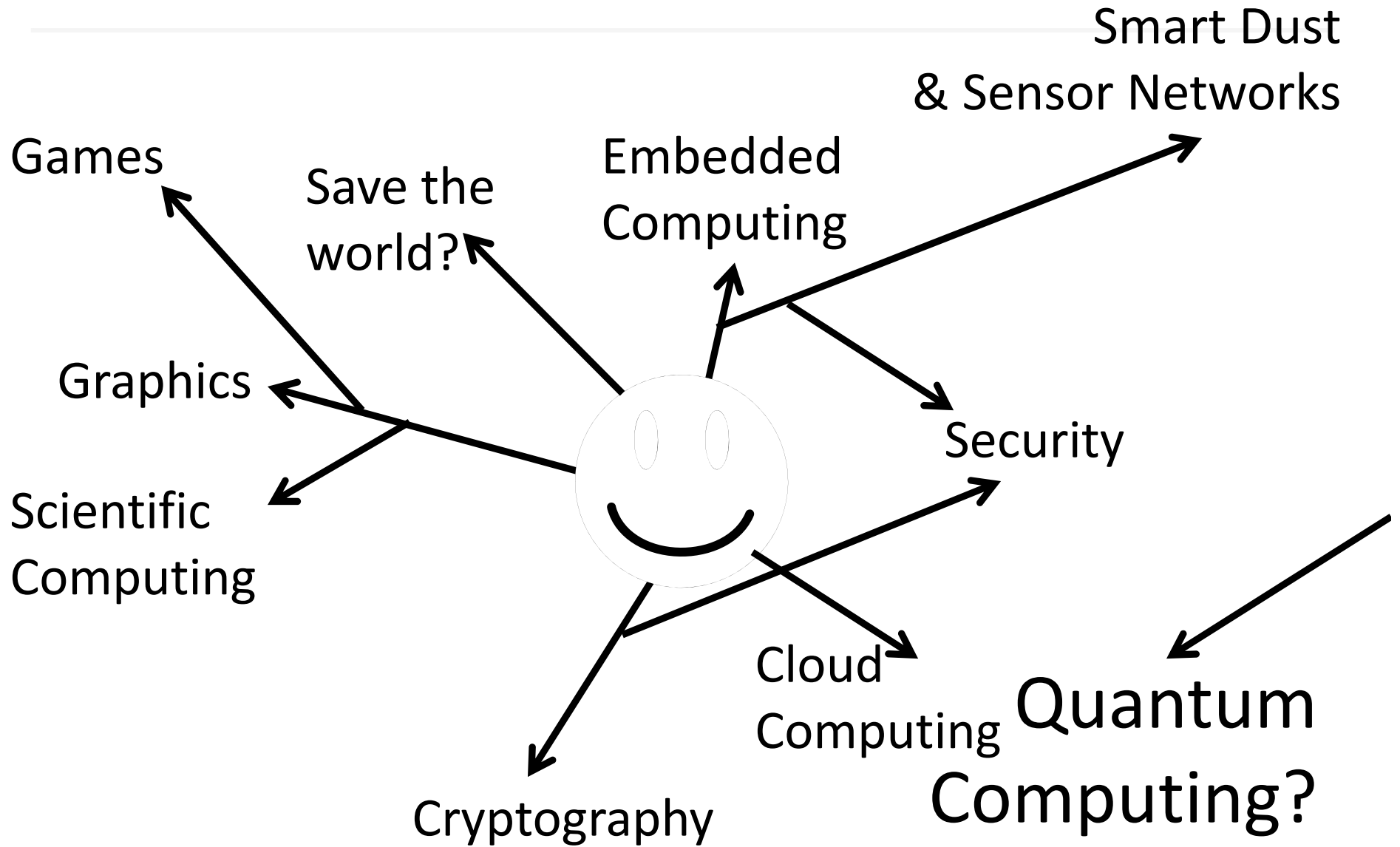

Survey Questions

Are you a better computer scientist and software engineering knowing “the low-level stuff”?

How much of computer architecture do software engineers actually have to deal with?

What are the most important aspects of computer architecture that a software engineer should keep in mind while programming?

Why?

These days, programs run on hardware...
... more than ever before

Google Chrome

- Operating Systems
- Multi-Core & Hyper-Threading
- Datapath Pipelines, Caches, MMUs, I/O & DMA
- Busses, Logic, & State machines
- Gates
- Transistors
- Silicon
- Electrons

Why?

Your job as a computer scientist will require knowledge the computer

Research/University

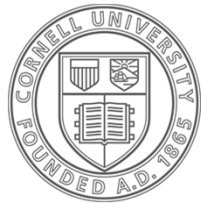

Cornell University
Faculty of Computing and Information Science

Industry



Government



Where to?

CS 3110: Better concurrent programming

CS 4410/4411: The Operating System!

CS 4420/ECE 4750: Computer Architecture

CS 4450: Networking

CS 4620: Graphics

~~CS 4821: Quantum Computing~~

MEng

5412—Cloud Computing, 5414—Distr Computing,

5430—Systems Security,

5300—Arch of Large scale Info Systems

And many more...

Thank you!

If you want to make an apple pie from scratch, you must first create the universe.

– Carl Sagan